

Shaping the power of the future

Installation Guide

Power Base 600 Grid tied energy storage system



System safety and environmental precautions

Product warranty becomes invalid if following precautions are not followed during handling, storage, installation, commissioning and operation of Pixii energy storage systems.

General precautions



Although this system incorporates protective circuits and other security features, it may still be destroyed, damaged, work poorly or shorten its lifetime if exposed to improper handling during transportation, installation or operation. Always handle the system with care, use proper lifting techniques, do not roll, climb or drill holes in the cabinet or enclosure.



Opening the equipment may cause serious injury even when the AC power is disconnected. Dangerous voltage may be present inside, as system can be still running from batteries or capacitors may still be charged.

Environmental precautions



Some devices can reach high temperatures during normal operation. It is very important to ensure that airflow through equipment is not blocked, filters are in good condition and fans can rotate freely. If other equipment is installed in close proximity, secure that inlets and outlets are not blocked.



Electronic devices installed in the energy storage system are designed for indoor environment with pollution degree 2. When installed in an outdoor enclosure (open or closed loop heat management system), it is important to ensure, that the enclosure is closed and sealed during normal operation, to avoid external air with increased level of humidity and dust from entering. In addition, in open loop systems, filters maintenance must be properly planned. In case of indoor systems, operating environment must be of pollution degree 2, without increased level of dust and humidity.



Installer is responsible to protect system against current surges, over-voltages, etc. caused by lightning, electrostatic discharges, etc. To avoid system damage, it is mandatory to always install proper SPDs.

Installation precautions



Read carefully user documentation before installation and using this equipment. Follow all commands, always use recommended tools and torque values as described. Commissioning and configuration of equipment should be done only by Pixii personnel or by other authorized and qualified persons.



For safety reason, before you start installation, ensure all external power sources are disconnected, as well as internal battery and load fuses/breakers. To avoid injuries caused by high leakage/touch current you must always start installation by connecting earthing wire (PE), before you connect other AC input wires (phases, neutral).

If system contains batteries, they represent major energy hazard. To avoid short circuit on batteries, do not operate with full metallic tools close to battery poles. Be careful also about other objects (rings, watches, necklaces, etc.).



All Pixii devices are certified according to international safety, environmental and EMC standards. If any other devices will be installed inside this product, it might influence parameters and violate original approvals. Installer is responsible that during installation environmental properties of this device are not impaired and installation is according to local regulations.

Battery safety and environmental precautions

For safety reasons, installers are responsible for familiarizing themselves with the contents of battery installation manual and all warnings before performing installation. Failure to observe the precautions described in this section can cause serious injury to persons or damage to property.

General precautions

The voltage of this battery module is strong enough to cause electric shock.

- Do not disassemble the battery module.
- Do not touch the battery module with wet hands.
- Do not expose the battery module to moisture or liquids.
- Keep the battery module away from children and animals.



The battery module may explode.

- Do not subject the battery module to strong impacts.
- Do not crush or puncture the battery module.
- Do not dispose of the battery module in a fire.



Keep the battery module away from open flame or ignition sources.

- Do not expose the battery module to temperatures in excess of 60°C.
- Do not place the battery module near a heat source, such as a fireplace.
- Do not expose the battery module to direct sunlight.
- Do not allow the battery connectors to touch conductive objects such as wires.



Risks of damage to the battery module.

- Do not allow the battery module to get in contact with liquids.
- Do not subject the battery module to high pressures.
- Do not place any objects on top of the battery module.



Environmental precautions

The battery module may leak corrosive electrolyte. Avoid contact with the leaking liquid or gas. Electrolyte is corrosive and contact may cause skin irritation and chemical burns.



The battery module should not be disposed of with household waste at the end of its working life.



The battery module should be disposed of at a proper facility for environmentally safe recycling



Installation precautions

Read the battery installation manual before installing and operating the battery module.

- Disconnect the charging source prior to connecting or disconnecting battery terminals.
- Determine if battery is inadvertently grounded. If inadvertently grounded, remove source from ground. Contact with any part of grounded battery can result in electrical shock. The likelihood of such shock can be reduced if such grounds are removed during installation and maintenance.



Wear appropriate personal protective equipment when dealing with the battery module.

- Remove watches, rings, or other metal objects.
- Use tools with insulated handles.
- Wear rubber gloves and boots.



The battery module is heavy enough to cause severe injury.



Response to emergency situations

While the battery module comprises multiple battery cells that are designed to prevent hazards resulting from failures, Pixii can not guarantee their absolute safety.

In the event that hazardous quantities of electrolyte are released, or in case of smoke, or fire, leave the battery room and contact the fire brigade.

Leaking batteries

If the battery module leaks electrolyte, avoid contact with the leaking liquid or gas. Electrolyte is corrosive and contact may cause skin irritation and chemical burns. If one is exposed to the leaked substance, do these actions:

Inhalation:

Evacuate the contaminated area, and seek medical attention immediately.

Eye contact:

Rinse eyes with flowing water for 15 minutes, and seek medical attention immediately.

Skin contact:

Wash the affected area thoroughly with soap and water, and seek medical attention immediately.

Ingestion:

Induce vomiting, and seek medical attention immediately

Rinse mouth and wash around the mouth with water.

Burns:

If burns are caused, treat them accordingly. Likewise, immediate medical attention shall be obtained.

Fire

In case of a fire, make sure that an ABC or carbon dioxide extinguisher is nearby. If a fire breaks out where the battery module is installed, do these actions:

1. Extinguish the fire before the battery module catches fire.
2. If the battery module has caught fire, do not try to extinguish the fire. Evacuate people immediately.



!!! Warning !!!

The battery module may catch fire when heated above 150°C.

If the battery catches fire, it will produce noxious and poisonous gases. Do not approach.

Wet batteries

If the battery module is wet or submerged in water, do not try to access it. Contact Pixii or your distributor for technical assistance.

Damaged batteries

Damaged batteries are dangerous and must be handled with extreme caution. They are not fit for use and may pose a danger to people or property. If the battery module seems to be damaged, pack it in its original container, and then return it to Pixii or your distributor.



!!! Caution !!!

Damaged batteries may leak electrolyte or produce flammable gas. If you suspect such damage, immediately contact Pixii for advice and information.

Information contained in this document can be changed without notice and does not represent a commitment on the part of Pixii.

No part of this document may be reproduced, copied or transmitted (electronic or mechanic, including photocopying and recording) for any purpose to 3rd party without the explicit written permission of Pixii.

Copyright © Pixii 2022

Document number: 14735, rev. 1.0

Date: 08.06.2022

author: petbinsk

Table of Contents

1 Introduction	8
1.1 Recommended tools and torque	8
1.2 Description	9
1.3 Thermal management system (TMS)	10
1.3.1 Fan filter	10
1.3.2 Air Conditioner with Heat Exchanger	11
1.4 Installation block diagram	12
1.4.1 Behind the meter	12
1.4.2 In front of the meter	12
1.5 System ratings	13
1.5.1 Electrical specifications	13
1.5.2 Environmental specifications	14
1.5.3 Mechanical specifications	15
1.5.4 Fuse list	18
1.6 Anti-islanding	18
2 Preparing installation site	19
2.1 Pre-installation steps	19
2.2 Recommended upstream breaker and input cable	20
2.3 Mains input metering	20
2.3.1 AMS energy meter	20
2.3.2 Industrial grade energy meter	21
3 Mechanical installation	22
3.1 Preparing site for installation	22
3.2 Lifting and positioning	23
3.3 Unpacking	24
3.4 Cabinets preparation	25
3.4.1 Removing the humidity stoppers	26
3.5 Placing	28
4 Electrical installation	29
4.1 Preparation	29
4.1.1 Bottom cover	29
4.1.2 Cable glands	30
4.2 Protective bonding	31
4.3 AC Mains Connection	32
4.3.1 TN-S (230/400Vac)	32
4.3.2 TN-C-S (230/400Vac)	33
4.4 Emergency disconnect switch	34
4.5 System label	34
4.6 Customer alarm connection	35
4.6.1 Separate alarm	36
4.6.2 Common alarm	36
4.7 Customer 230V	37
4.8 External communication	37
4.8.1 Wi-Fi Access Point	37
4.8.2 4G router connection	38
4.8.3 Ethernet connection	38
4.9 Customer space	38
4.10 AC meter connection	39
4.11 Customer MODBUS connection RS485	39

4.12 Thermostat	40
4.13 Finalization	40
4.14 Installing batteries	41
4.15 Battery connection	43
4.15.1 Battery Com converter	44
4.16 Power modules	45
4.16.1 Installing module	45
4.16.2 Removing module	45
5 Commissioning procedure	46
6 Maintenance	46
6.1 System	46
6.2 Fan-filter cabinet	46
6.3 Air condition unit	46

1 Introduction

This document describe step by step installation, commissioning and start-up of energy storage system. Read it carefully and follow all recommendations to be sure system is running in correct environment under good conditions and installation reached all safety requirements.

1.1 Recommended tools and torque

	Tool
W	Wrench
PZ2	Pozidriv screwdriver
Flat	Flat screwdriver
T-W	Torque wrench
T-PZ2	Torque Pozidriv screwdriver

Table 1. Recommended tools

	Type & Size	Torque
T1	Terminal block (WDU2.5)	0,4Nm
T2	Input Connector 4x50-240 (PE, N)	45Nm
T3	Input Connector 4x95-240 (L1, L2, L3)	50Nm
T4	Polarium batteries (DC cables)	15,0Nm
T5	Terminal block (WDK2.5)	0,4-0,6Nm
T6	Terminal block (DLD 2.5)	0,4-0,6Nm
T7	Relay socket	0,5Nm
T8	M6	9,8Nm
T8	M10	47,0Nm

Table 2. Recommended torques

1.2 Description

The power system consist of 13 cabinets:

1x ACD	-	AC Distribution Cabinet	-	UH1
1x PWM	-	Power Master Cabinet	-	CC6
11x PWS	-	Power Slave Cabinet	-	CC1 - CC5, CC7 - CC12

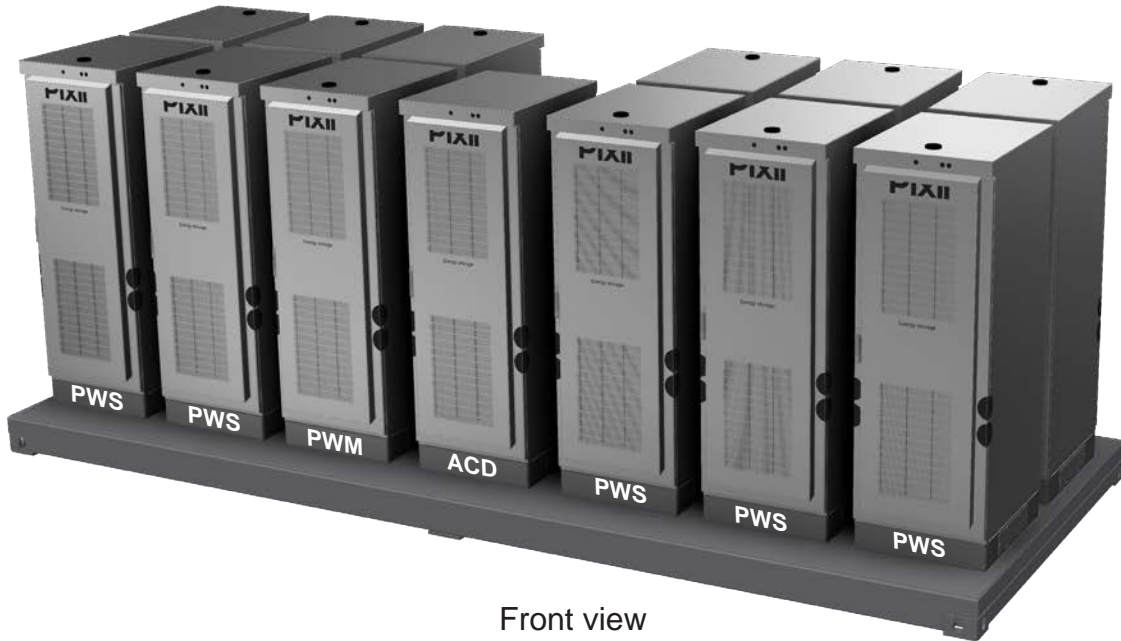

Front view

Figure 1.1 Power system - front view

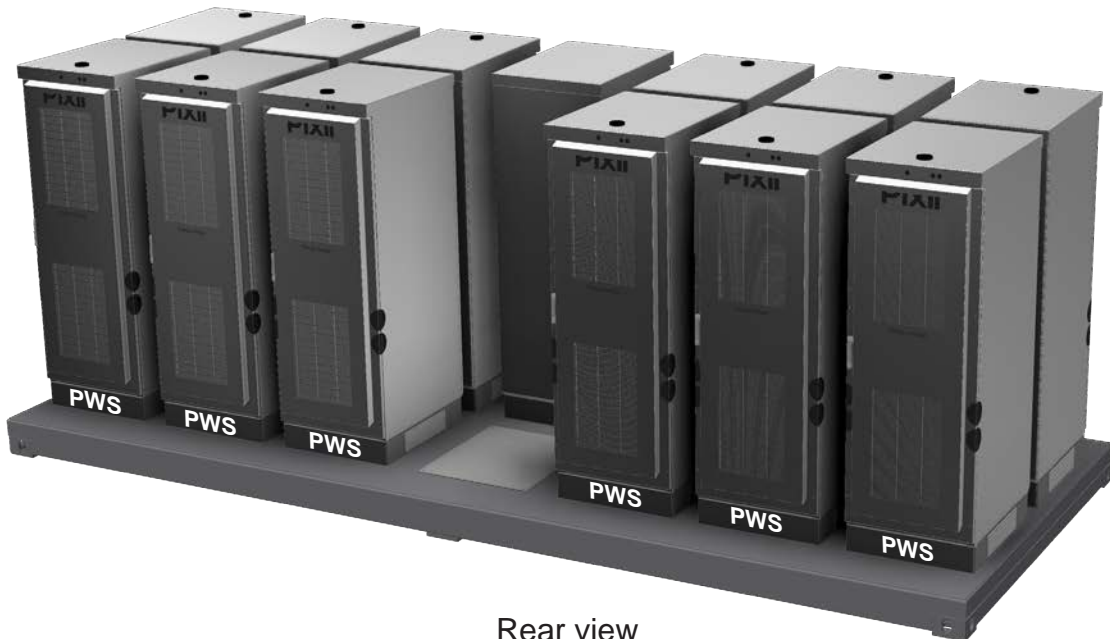

Rear view

Figure 1.2 Power system - rear view

1.3 Thermal management system (TMS)

Cabinet thermal management system provides appropriate thermal conditions inside the cabinet. Solution is integrated on the cabinet door with controlled air flow inside the cabinet.

There are two options – Fan Filter or Hybrid Air Condition & HEX solution.

1.3.1 Fan filter

Fan filter TMS using free cooling principle which is open loop system. Outside cold air is pulled into the cabinet through the inlet filter and hot air is pushed out through the outlet filter. Inlet filter with two fans is installed at the bottom and outlet filter at the top of the door. This principle provides overpressure in the cabinet. Input and output air is filtered from dust or other particles. The filter must be changed when the cabinet is no longer able to maintain the required temperature level. Filter change interval depends on different factors as pollution, heat dissipation, thermal requirements or solar load.

The advantage of free cooling is large amount of exchanged air which is giving very high cooling performance at low power consumption. The temperature inside the cabinet is always higher than ambient (outside) temperature. With moderate ambient temperatures or low power dissipation the fans will be running at low speed. As the ambient temperature or internal power dissipation increases the fan speed will increase.

Fan filter solution also provides additional air recuperation mounted inside the door, helping to spread the air evenly in the cabinet. It secures similar temperature around the batteries.

Cabinet is equipped with 2x 500W AC powered heaters for lower temperature conditions securing adequate battery temperature.

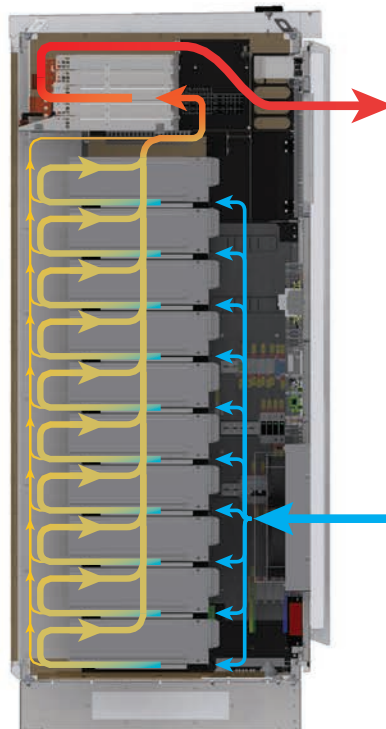

Figure 1.3 Fan filter air flow diagram (side view)

1.3.2 Air Conditioner with Heat Exchanger

The HC series Air Conditioner with Heat Exchanger is a cooling product developed for cabinets. It is applicable for the scenarios where internal equipment of the cabinet emits a large quantity of heat and needs to be isolated from the outdoor environment completely. The unit integrates the heat pipe exchanger with air conditioner. When the external ambient temperature is lower than the cabinet inner temperature, the heat pipe exchanger takes precedence to work, and realize reduce heat-dissipating consumption.

The operating principle of Air Conditioner with Heat Exchanger is shown in *Figure 1.4*. The heat exchange system and air conditioner share the same indoor/outdoor fans.

The heat exchanger and the compressor of the Air Conditioner with Heat Exchanger adopt grading interlocking control. The heat exchanger is defined as the first level heat dissipation and the compressor is defined as the second level cooling. According to the cabinet internal/external temperatures, dividing into four working modes: internal fan running, heat exchanger running, air conditioner running and both running.

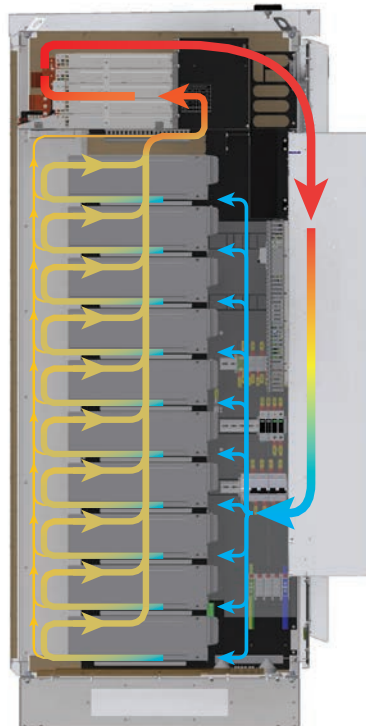

Figure 1.4 Air condition air flow diagram (side view)

NOTE:

The air conditioner shall be kept vertically strictly in accordance with the instructions on the package during transportation, storage and use.

Default settings

Aircon is pre-set from factory to the temperature 23°C +/-5°C. If this setting is not acceptable for conditions on site, set appropriate temperatures following instructions in the *User manual HC Series Air Conditioner with Heat Exchanger*.

1.4 Installation block diagram

1.4.1 Behind the meter

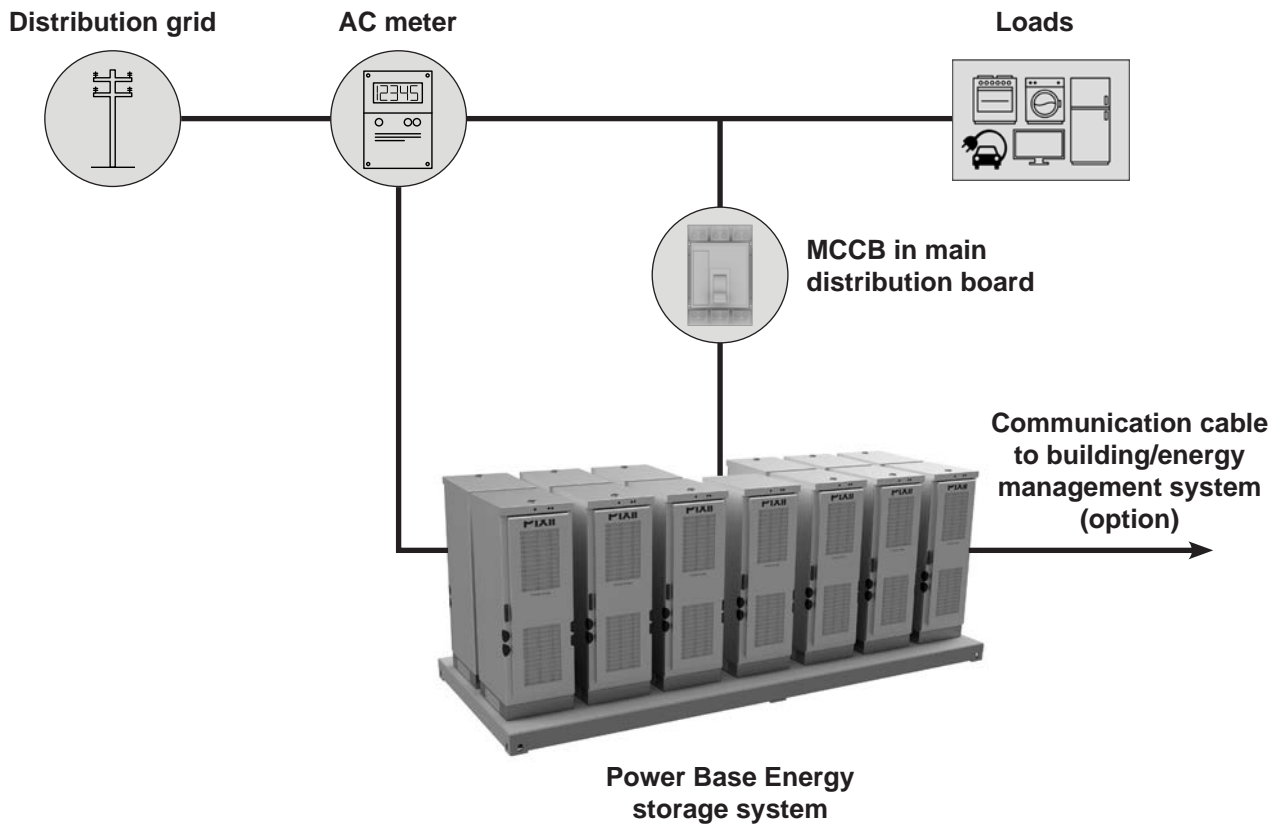

Figure 1.5 Single line installation block diagram - behind the meter

1.4.2 In front of the meter

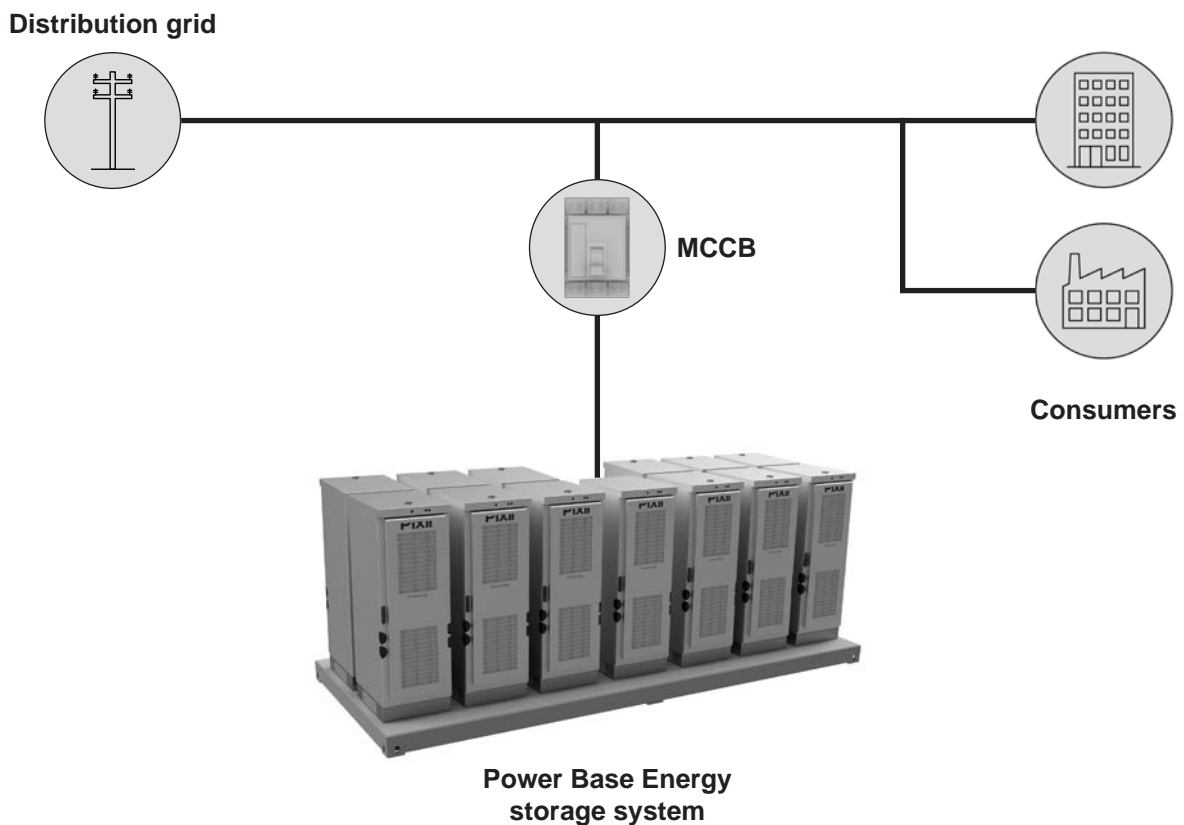

Figure 1.6 Single line installation block diagram - in front of the meter

1.5 System ratings

1.5.1 Electrical specifications

The Power Base system consist of PowerShaper system with modular converters. Each of them providing transformers with Reinforced insulation between AC side and the DC side.

AC Mains Type	TN
Max. Active Power (charge and discharge)	600kW ¹ /480kW ^{2,3}
Max. Apparent Power (charge and discharge)	600kVA ¹ /480kVA ^{2,3}
AC voltage	400/230V, 3Ph+N+PE
Max. AC current	996Arms, 3Ph+N+PE
Nominal AC current	864Arms, 3Ph+N+PE
Frequency range	45Hz to 66Hz
Cos φ range	0.5 inductively to 0.5 capacitively
Protective class	Class I
Overvoltage category	OVC III
Supply system	TN
Max. short circuit current	50kA
Type of short-circuit protective device	MCB
Max. Energy	576kWh ¹ /1238.4kWh ² /1440kWh ³
Max. DC voltage	44V to 58V

Table 3. Electrical specifications

Type of the battery	¹ Polarium SLB48-100	² Polarium SLB48-250	³ Polarium SLB48-300
Nominal capacity	100Ah	250Ah	300Ah
Nominal energy	4.8kWh	12.9kWh	15kWh
Operating voltage	39V-54.75V	35V-58.8V	35V-58.8V
Max. charge/discharge current	100A		

Table 4. Specifications of the batteries

Voltage fluctuations and flicker (for one system):

	P_{st}	P_{lt}	Z
Measured using Z_{test}	0,645	0,603	0,013 Ω +j0,002 Ω
Maximum permissible network impedance, Z_{max}	-	-	0,093 Ω +j0,093 Ω

Table 5. Voltage fluctuations and flicker *

* Measurements above tested on a PowerShaper 50kW system.

1.5.2 Environmental specifications

Type of cabinet	with Fan-Filter	with Air condition
Operating temperatures	-20°C to +45°C	-20°C to +50°C
Humidity	5% to 95% RH (non-condensing)	
Storage and transportation temperatures	-30°C to +60°C	
Storage and transportation humidity	5% to 95% RH (non-condensing)	
Storage (less than 12 months)	State of Charge (SoC): 25%	
Acoustic noise (maximum)	<50dBA at 1m distance	
Maximum altitude	2000m	
Ingress protection rating	IP55	
Impact rating	IK09	
Pollution degree	3	
Wet locations	Yes	
Current (inrush)	25A _{peak} *	
Maximum output fault current	200A _{peak} /1ms*	
Inverter topology	Isolated	
Env. cat. (IEC 62040-1:2017)	Indoor, conditioned	Outdoor
Env. cat. (IEC 62040-1:2013)	Outdoor	
Env. cat. (IEC 62368-1)	Outdoor	
Env. cat. (IEC 60950-1)	Outdoor	
Env. cat. (IEC 62477-1)	Indoor, conditioned	Outdoor
Env. cat. (AS 4777.2:2020)	Indoor, conditioned	Outdoor**

Table 6. Environmental specifications

* Measurements above tested on a PowerShaper 50kW system.

** The Outdoor system rated up to only 50°C must be protected from solar radiation

1.5.3 Mechanical specifications

Power system

Height (with support plate)	2344mm
Width (with support plate)	6058mm
Depth (with support plate)	2438mm
Weight (without modules and batteries)	4450kg
Weight (fully equipped, 3U batteries)	9850kg
Weight (fully equipped, 4U 250Ah batteries)	10790kg
Weight (fully equipped, 4U 300Ah batteries)	11750kg

Table 7. Mechanical specifications - Power system

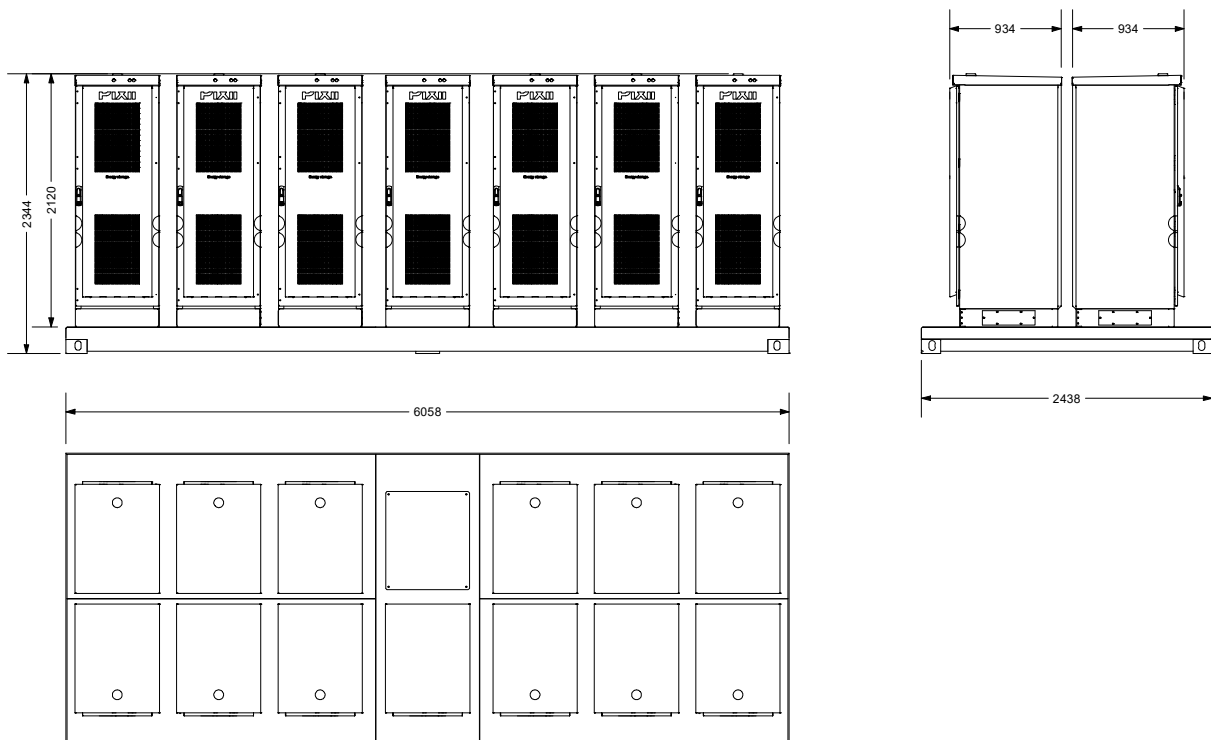

Figure 1.7 Mechanical specifications

AC Distribution Cabinet (ACD)

Type of Cabinet	Fan Filter
Height	2106mm
Width	706mm
Depth	932mm
Weight	200kg

Table 8. Mechanical specifications - ACD cabinet

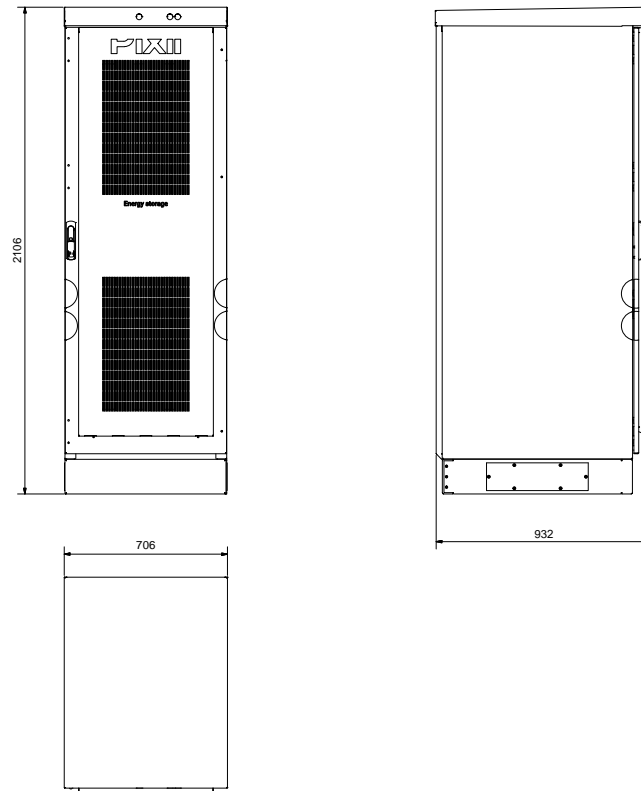

Figure 1.8 Fan Filter Cabinet dimensions

Power Cabinet

Power Cabinet (PWM, PWS)

Type of Cabinet	Fan Filter	Air Condition
Height	2106mm	
Width	706mm	
Depth	932mm	1064mm
Weight (without modules and batteries)	220kg	265kg
Weight (fully equipped, 3U batteries)	700kg	745kg
Weight (fully equipped, 4U 250Ah batteries)	780kg	825kg
Weight (fully equipped, 4U 300Ah batteries)	860kg	905kg

Table 9. Mechanical specifications - Power cabinets

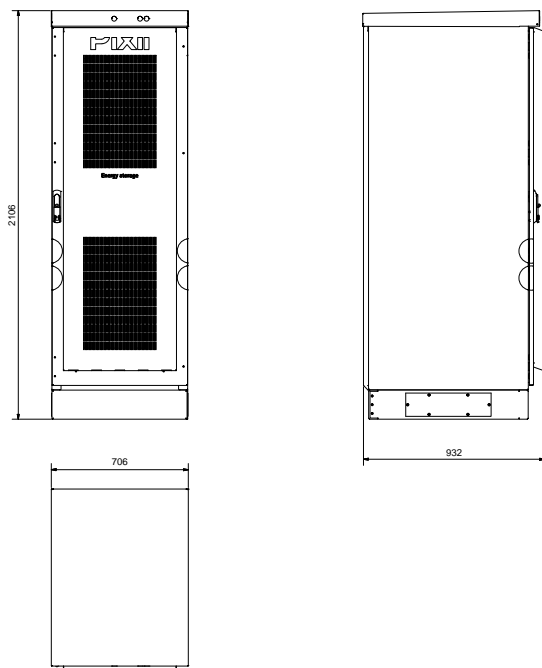

Figure 1.9 Fan Filter Cabinet dimensions

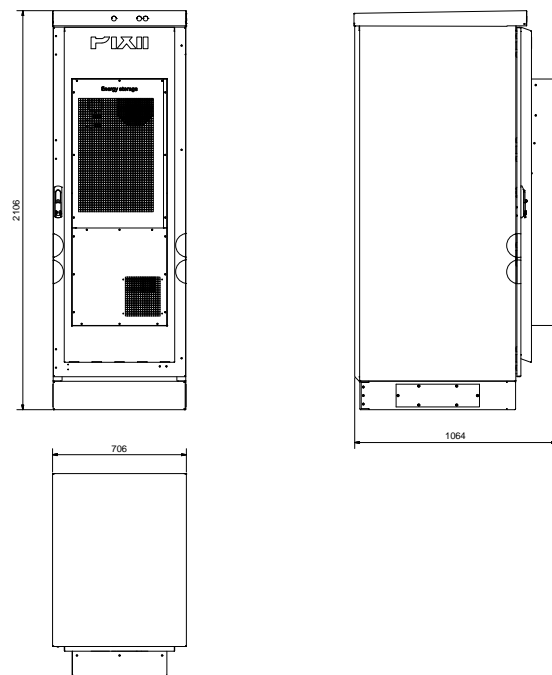

Figure 1.10 Air Condition Cabinet dimensions

1.5.4 Fuse list

Power Cabinets (PWM, PWS)

	Type	Manufacturer	Manufacturer part number
-FC2	10A 2-pole B-curve	Schneider	A9F03210 A9F53210 (AS/NZS 60898.1:2004)
-FC13	10A 5x20mm slow	Littelfuse	0477010.MXP
-FC14	10A 5x20mm slow	Littelfuse	0477010.MXP
-FC20	10A 6,4x32mm fast 10kA	Bussmann	ABC-10-R
-FC21	10A 6,4x32mm fast 10kA	Bussmann	ABC-10-R
F201	0,5A 5x20mm slow	Littelfuse	0477.500MXP
F202	3,15A 5x20mm slow	Littelfuse	04773.15MXP
F203	3,15A 5x20mm slow	Littelfuse	04773.15MXP

Table 10. Fuse list for Power cabinets

AC Distribution cabinet (ACD)

	Type	Manufacturer	Manufacturer part number
-FC1-FC12	1250A 4-pole C-curve	Schneider	A9N18480 A9N18374 (AS/NZS 60898.1:2004)
-FC20	1250A 3-pole MCCB	Schneider	33478+ 33662 (optional)
-FC21	125A (gL/gG) 14x51mm 100kA	Citel	64048
-FC22	0,5A 5x20mm slow	Littelfuse	0477.500MXP
-FC23	0,5A 5x20mm slow	Littelfuse	0477.500MXP
-FC24	0,5A 5x20mm slow	Littelfuse	0477.500MXP
-FC25	0,5A 5x20mm slow	Littelfuse	0477.500MXP
-FC26	0,5A 5x20mm slow	Littelfuse	0477.500MXP
-FC27	0,5A 5x20mm slow	Littelfuse	0477.500MXP

Table 11. Fuse list for AC Distribution cabinet

NOTE:

Please consult replacement of any fuse or circuit breaker with Pixii first.

1.6 Anti-islanding

The PowerShaper incorporates both passive and active anti-islanding functionality. The passive methods included are under/over voltage, under/over frequency and rate of change of frequency detection. The active anti-islanding functionality uses the frequency shift method based on feedback from frequency variation in combination with a small reactive power perturbation. The active anti-islanding function may be disabled for grid codes not accepting such means of islanding detection.

2 Preparing installation site

2.1 Pre-installation steps

1. Organize installation site

- Mounting base strong enough to carry weight of fully equipped system (approx. 11750kg)
- Clearances for cabinet access

	Minimum distance	Suggested distance
Front	35cm	100cm
Rear	35cm	100cm
Top	30cm	90cm
Sides	30cm	60cm

Table 12. Recommended Installation distances and clearances

NOTE:

It is strictly required to follow local regulations if separation distances larger than the table above are required.

NOTE:

If the energy storage system is installed indoor, automatic sprinkler system is highly recommended and sometimes required. Local regulations must be adhered to.

2. Prepare installation tools

- Use insulated tools suitable for electrical installations
- Recommended tools list is in chapter "Recommended tools" on page 8.

3. Prepare AC Mains supply

- Correct type of AC Mains supply (TN-S/TN-C)
- Correct rating of AC input cables and external fuses
- AC Mains supply meter

2.2 Recommended upstream breaker and input cable

To reach stable system operation, it is very important to use proper input cable and upstream breaker. The minimum recommended values for different types of networks can be found in table below.

AC Mains Type	Maximum current	Upstream breaker	Input cable
230/400Vac 3-phase, TN-S network 5-wire system	996A	1250A C-curve	4x 240mm ² PVC (CU) 4x 240mm ² XLPE (AL)
230/400Vac 3-phase, TN-C-S network 4-wire system			

Table 13. Recommended upstream breaker and input cable

!!! WARNING !!!

System is designed to operate on 1-phase or 3-phase networks. It is strictly forbidden to connect multiple single-phases to the system.

NOTE:

If different number of power shelves or breaker with lower rating needs to be used from any reason, discuss possibilities with Pixii.

NOTE:

Breaking capacity of input breaker installed in system is 50kA, upstream breaker breaking capacity must correspond to AC grid conditions at the point of installation.

NOTE:

Cable type, upstream breaker and RCD depends on local conditions and regulations.

2.3 Mains input metering

To secure correct operation, system must have actual readings from mains input AC meter. Therefore compatible meter must be installed on site. Measured values are important to perform autonomous operation functionality such as peak shaving and others. Pixii system has support for communicating with 2 different types of meters.

NOTE:

Measured data are used at the customer's own risk. The distribution company or Pixii is not responsible for any losses resulting from its use, including losses due to errors or omissions in the data.

2.3.1 AMS energy meter

AMS meter allows for monitoring consumption and production down to a few second intervals through the HAN-port (M-Bus) according to Norwegian HAN-port specification. The HAN-port is closed by default. Contact your local network company to open it. Before opening the HAN-port, the network company will first ask some questions related to securing the gate for privacy reasons. For connecting to the HAN-port a standard Ethernet cable with RJ45 connectors is required. Maximum practical distance at highest speed is 350 meters.

2.3.2 Industrial grade energy meter

The Pixii system has support for an energy meters Phoenix Contact EEM-EM355 (external measuring transformers required) and EEM-EM357 (direct internal measuring up to 80A). Currently, communication via Modbus/RTU (RS485) is supported. This means that a cable (2-wire at least) needs to run from the meter to the controller in system. Maximum practical distance is 300 meters.

Supported AC Meters

- Phoenix Contact EEM-EM357
 EEM-EM355
 EEM-MA370-R
 EEM-MA371-R
- Schneider iEM 3255
- Accuenergy Acuvim IIR-D-5A-P1 + AXM-WEB2

3 Mechanical installation

3.1 Preparing site for installation

To secure correct system operation, PowerBase must be properly fixed to solid horizontal leveled surface. Because of small space in plinth and easier installation, it is recommended to prepare all cables in area directly under cable entries of ACD cabinet. See *Figure 3.1* for cable entries dimensions and positions. Support construction must be placed on flat surface or on 6 solid resting points, see *Figure 3.2*.

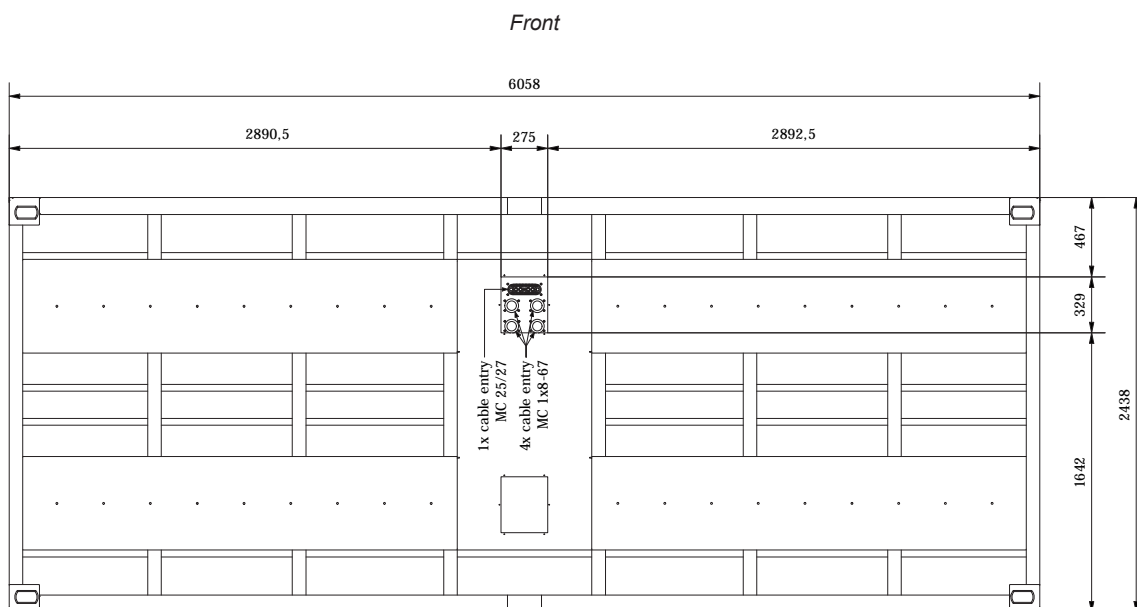

Figure 3.1 Cable entries - bottom view

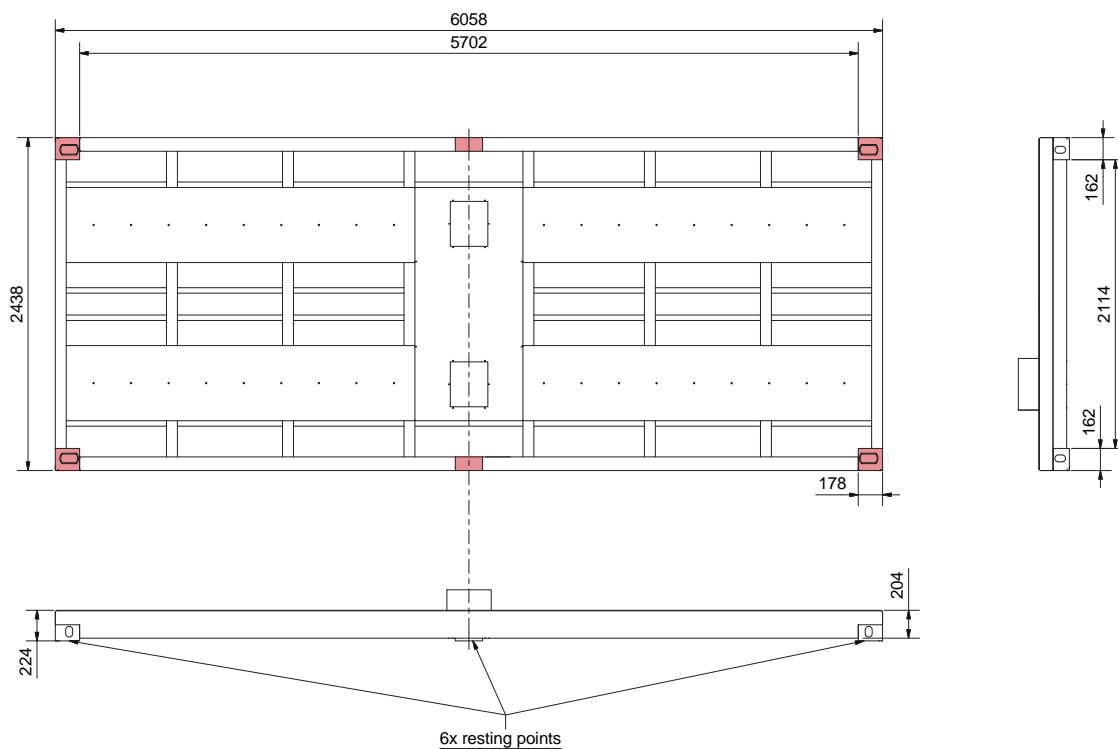

Figure 3.2 Resting points

3.2 Lifting and positioning

- Fix chains or straps to all corners (see *Figure 3.3*), securely lift and move the system.

!!! WARNING !!!

Appropriate traverse and container lifting hooks must be used for lifting.
Do NOT use any other technique to lift the cabinet because of imminent damage.
Do NOT lift cabinet with installed modules and batteries.

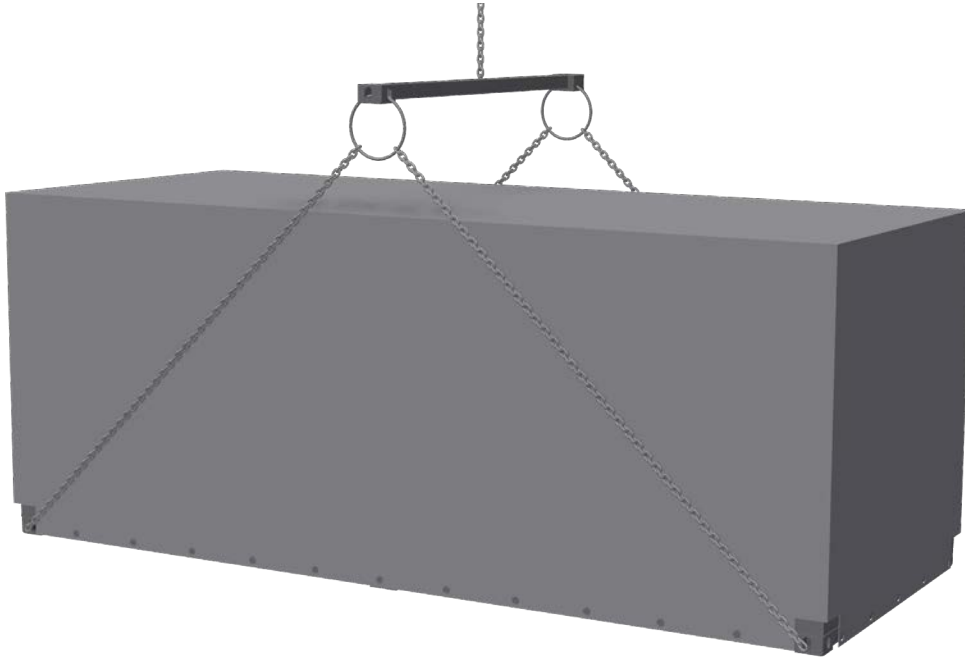

Figure 3.3 Lifting and positioning

3.3 Unpacking

- Place the structure on the floor and remove the tarpaulin from the system.

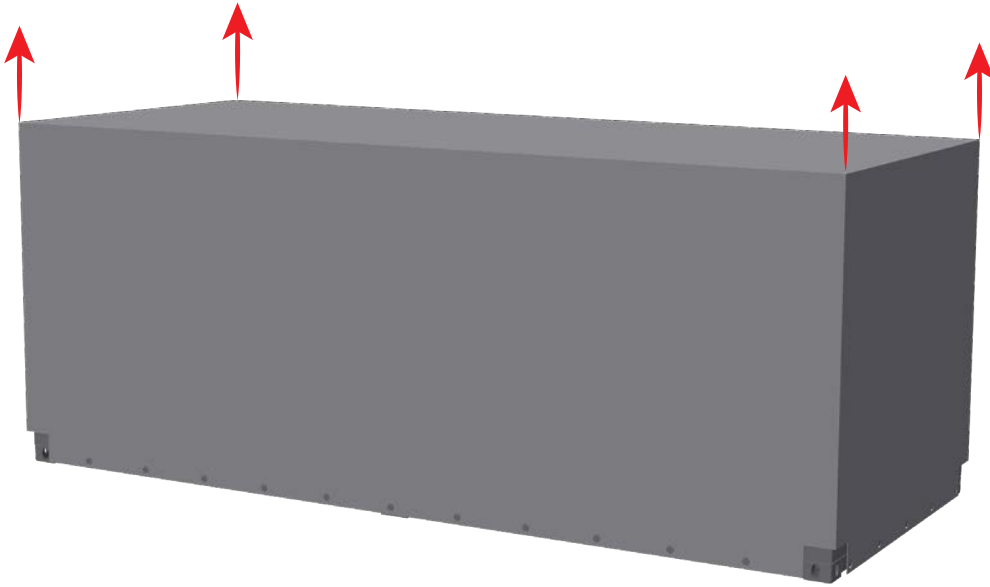

Figure 3.4 Removing the tarpaulin

- Remove the foam top caps and other packing material from cabinets.

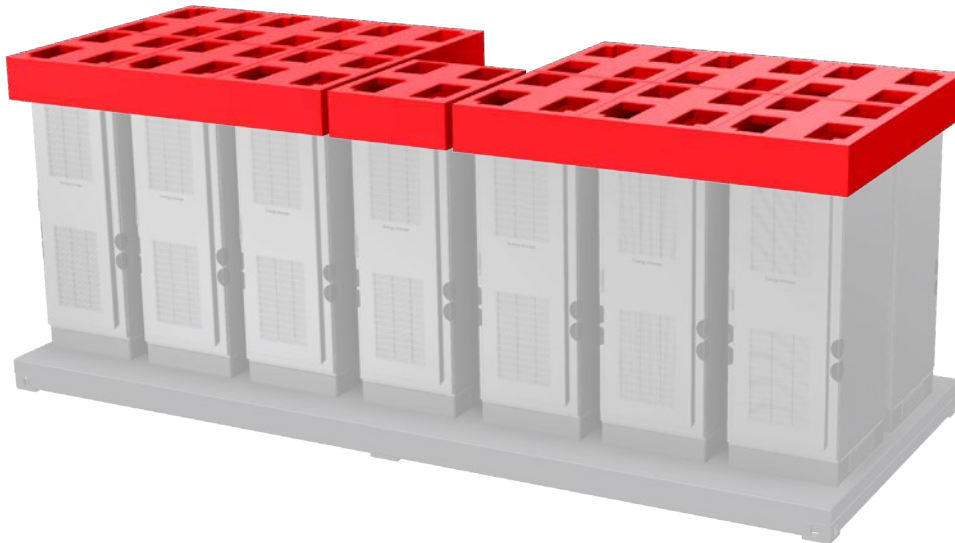

Figure 3.5 Removing the foam caps

3.4 Cabinets preparation

- Put out the roof L-bracket from the cabinets and mount it on the top of the cabinets using attached M6 nuts.
- Put out the roof panel from the cabinets, mount the roof panel on the top of the cabinets and connect antenna cable (if present).

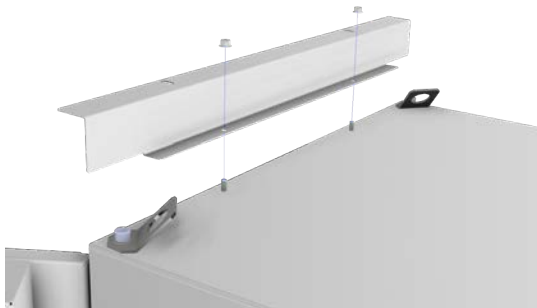

Figure 3.6 Mounting the L-bracket

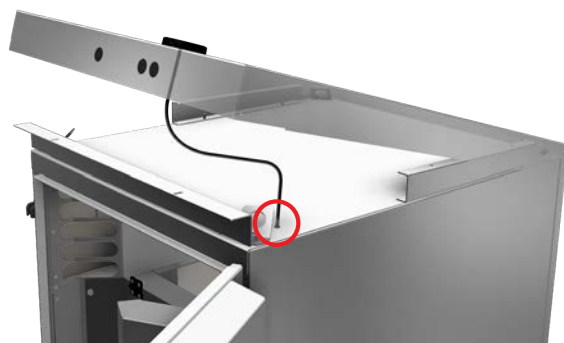

Figure 3.7 Mounting the cabinet roof

- Fix the roof panel to the all cabinets with 2x M6 nuts for each panel.
- Open the cabinet door in ACD and secure them with door lock.



Figure 3.8 Fixing the cabinet roof

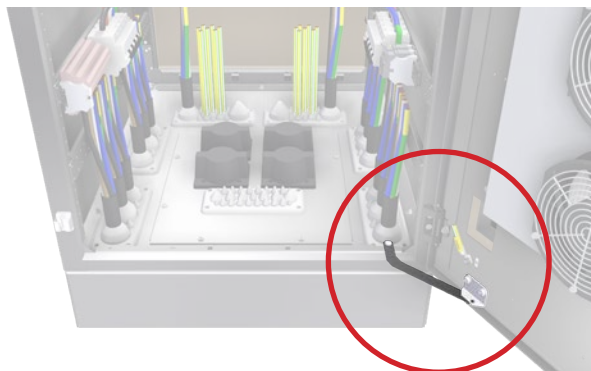

Figure 3.9 Locking the door

- Remove the bottom cover with cable glands releasing 8xM6 trox screws.
- Remove the 5x cable glands from the bottom cover by releasing 4x M6 screws for each gland.

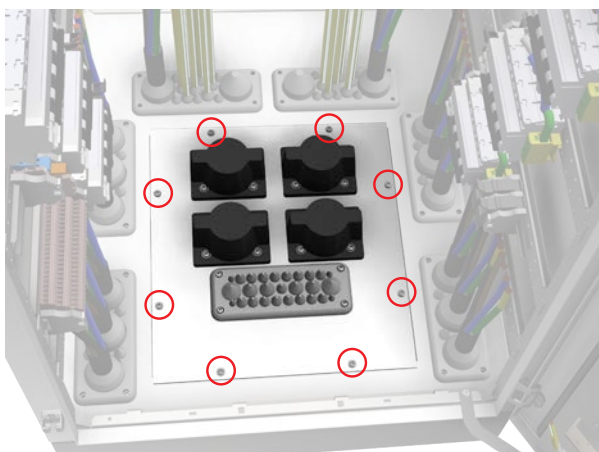

Figure 3.10 Removing the bottom cover

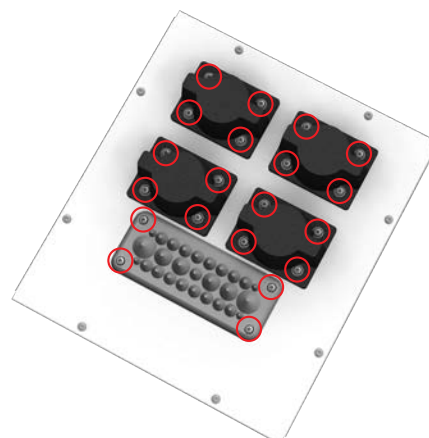

Figure 3.11 Removing the cable glands

NOTE:

Keep fixings and cover at safe place, as you need them later!

NOTE:

Connect antenna to the PWM cabinets only, other cabinets are antenna free.

3.4.1 Removing the humidity stoppers

To secure correct function of Fan filters, it is necessary to remove all humidity stopper foils from inlet/outlet filters.

Outlet filter

1. Remove 8x M6 Nuts to release filter holders.
2. Remove humidity stopper.

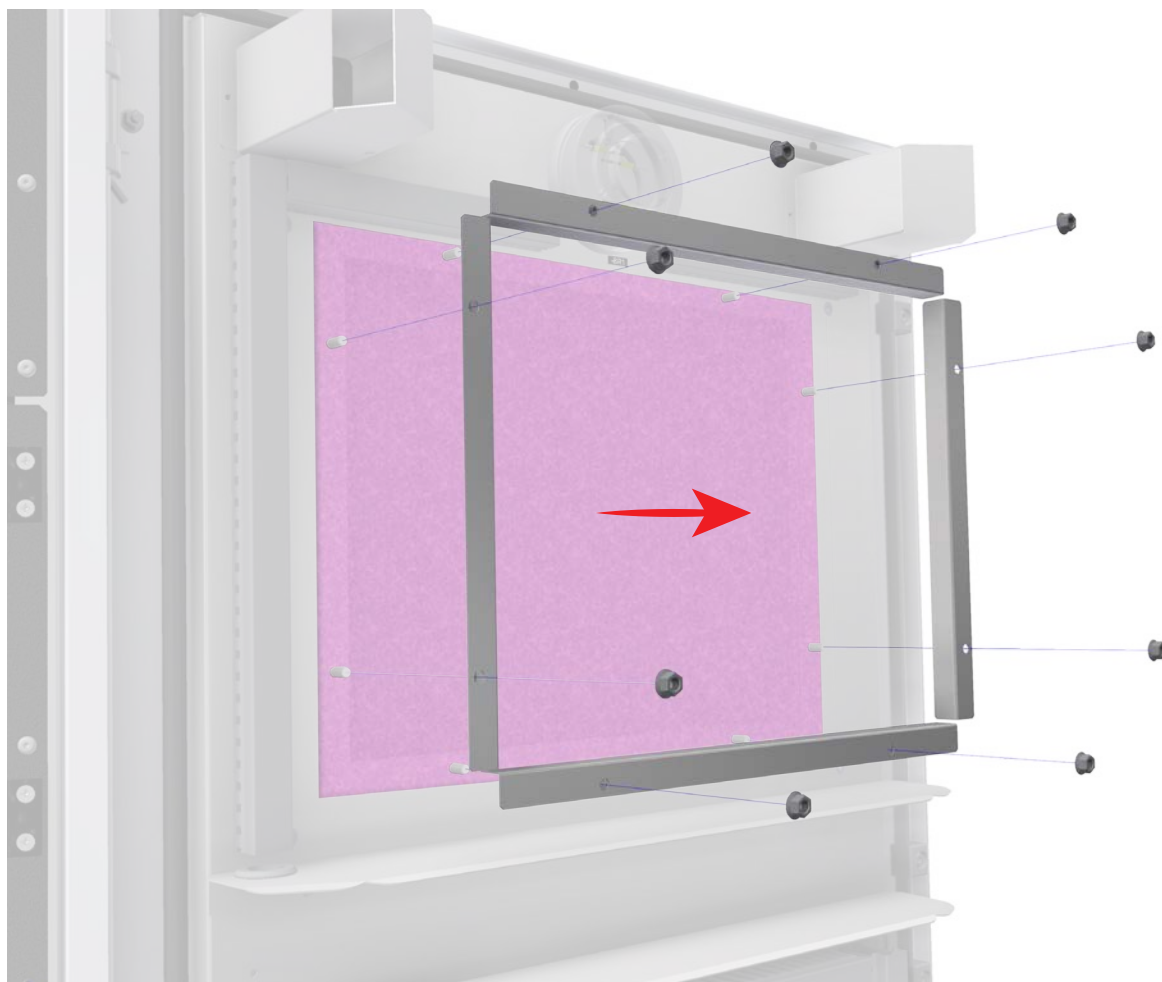

Figure 3.12 Humidity removal in outlet filter

3. Fix back all filter holders with 8x M6 Nuts from first step.

Inlet filter

1. Remove 4x M6 Nuts to release filter frame.
2. Remove humidity stopper.

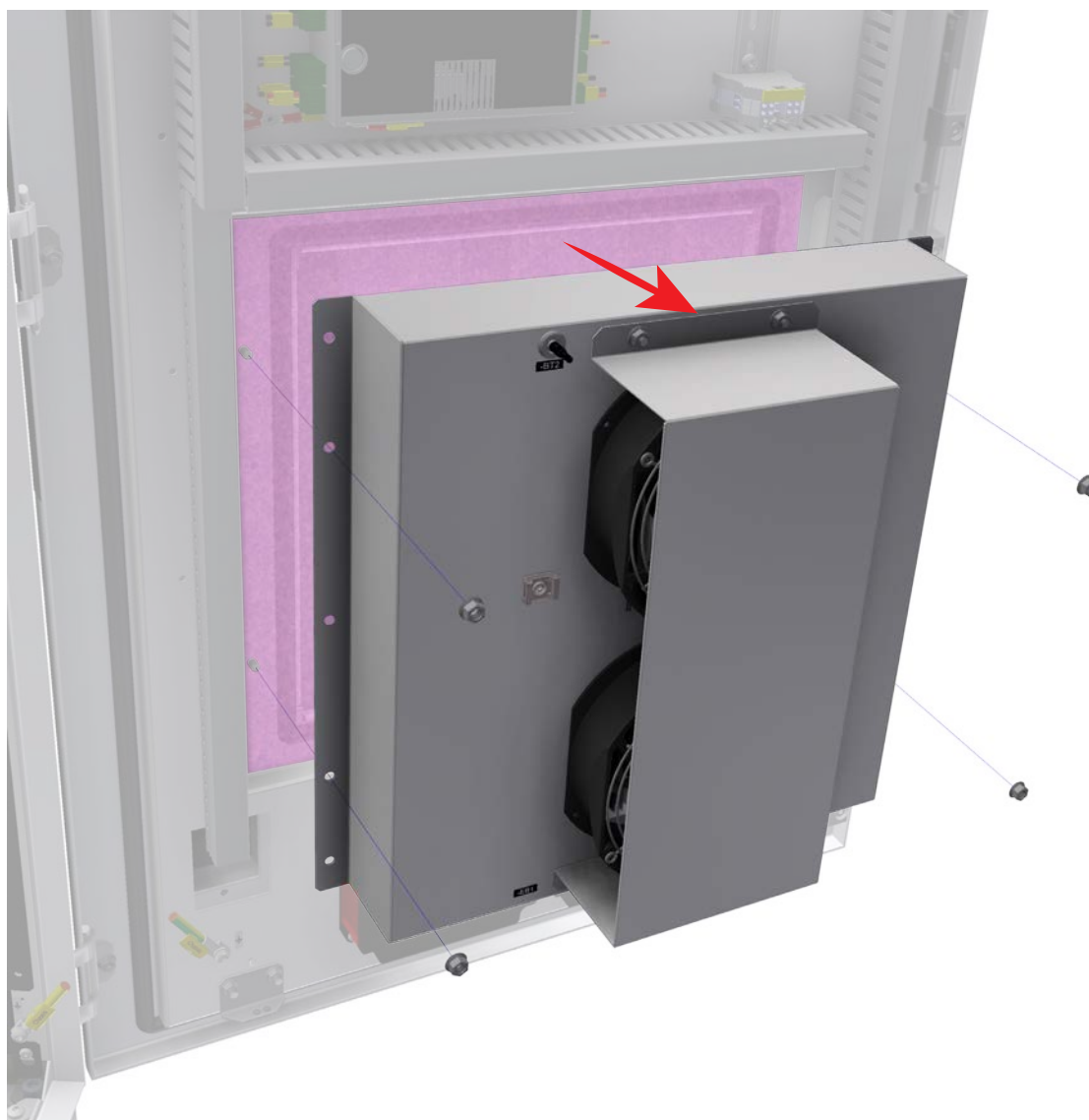

Figure 3.13 Humidity removal in inlet filter

3. Fix back filter frame with 4x M6 Nuts from first step.

NOTE:

Gap between filter frame and the door plate is not a fault. Do NOT tighten screws too strong to reduce the gap.

3.5 Placing

- Lift the structure, using method described in chapter “3.2 Lifting and positioning” on page 23.
- Move it to the desired position, align it with input cables, and slowly run down.
- Insert cables through the openings, where the cables glands were installed.
- Continue the process, pull the cables out of the cabinet (through the opened door), until the structure reach the ground.

NOTE:

Do NOT forget to open and secure the door on ACD cabinet.

NOTE:

Ensure, that input cables are NOT colliding with the equipment in the cabinet during the run down process.

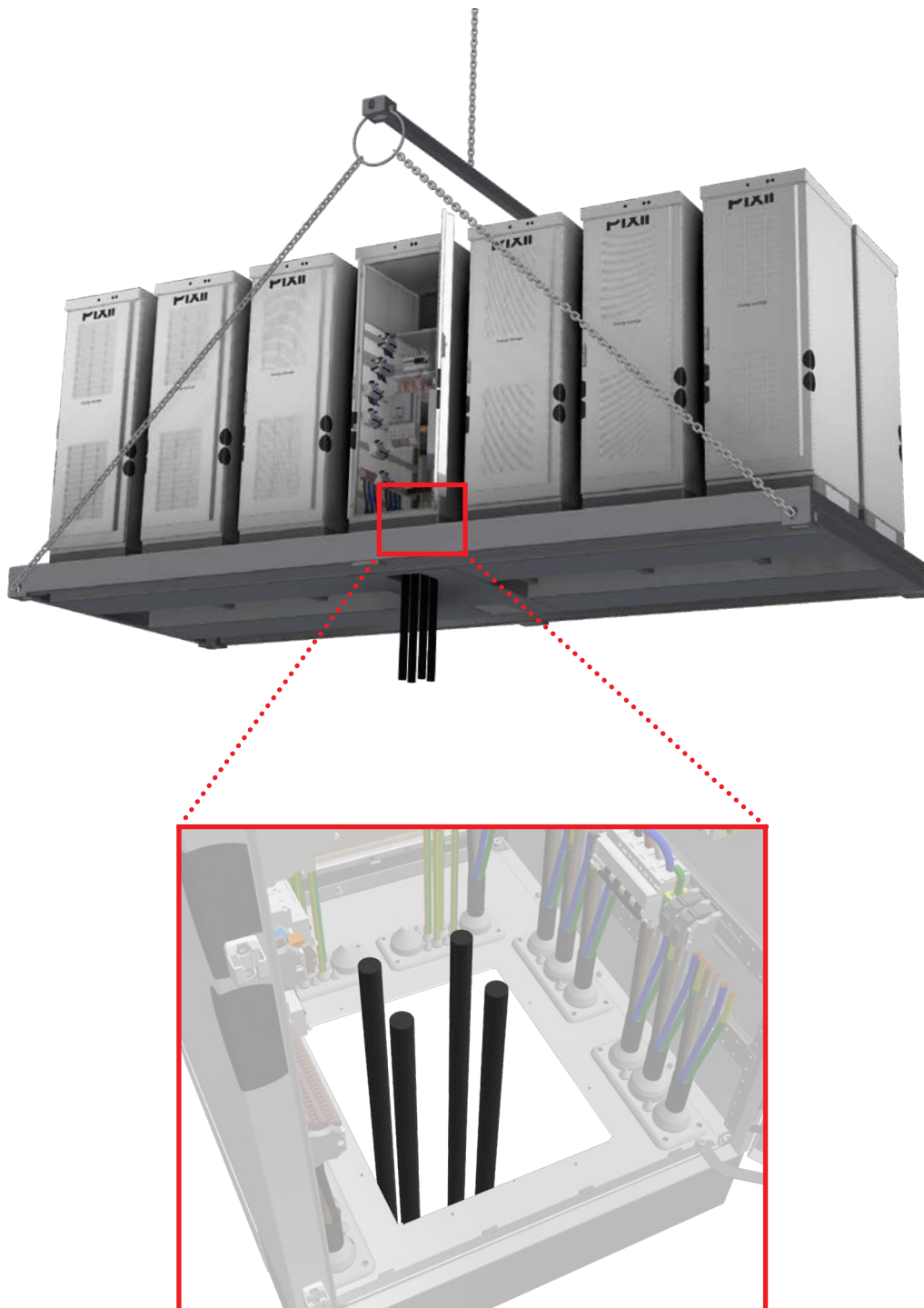

Figure 3.14 Placing of the structure

4 Electrical installation

For safety reason, before you start installation, ensure all external power sources are disconnected, as well as internal battery and load fuses/breakers. To avoid injuries caused by high leakage/touch current you must always start installation by connecting earthing wire (PE), before you connect other AC input wires (phases, neutral).

4.1 Preparation

Remove plastic cover (highlighted in yellow) by releasing 8x M6x10 torx screws for each cover.



Figure 4.1 Removing the plastic covers

NOTE:

Keep fixings and cover at safe place, as you need them later!

4.1.1 Bottom cover

Route cables through the openings in the bottom cover and fix the cover with 8xM6 torx screws from chapter “3.4 Cabinets preparation” on page 25.

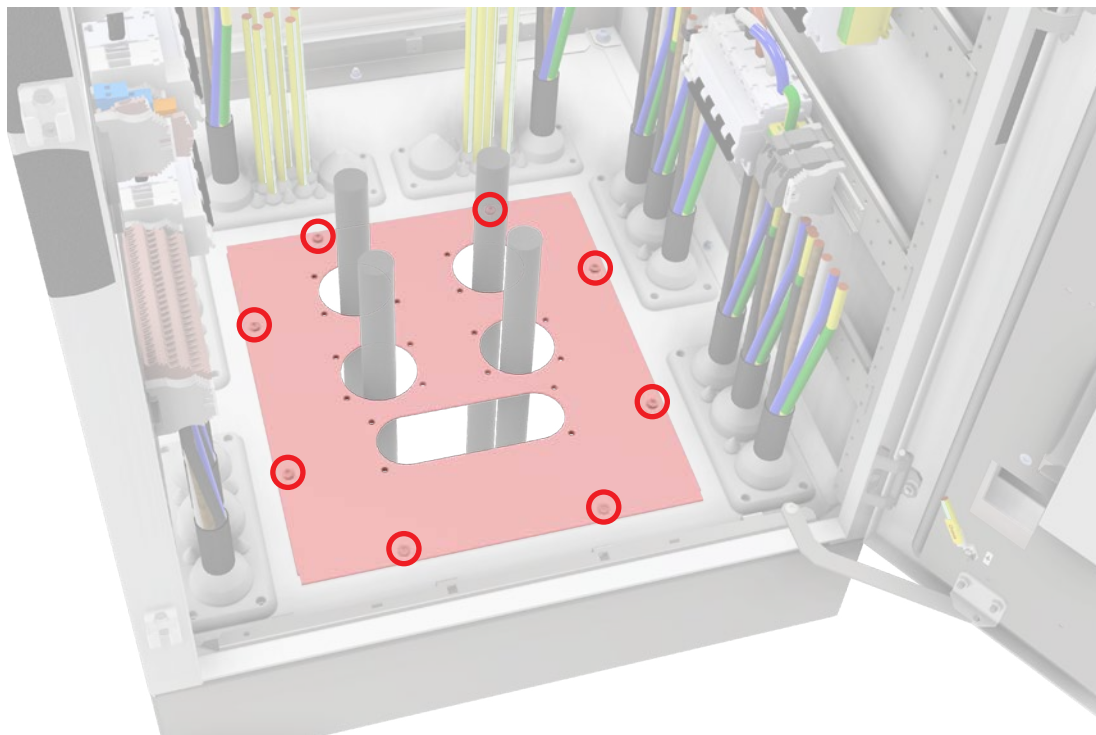

Figure 4.2 Installing the bottom cover

4.1.2 Cable glands

Run cables through the cable glands, seal them and fix them to the ACD cabinet bottom cover with screws from step “3.4 Cabinets preparation” on page 25.

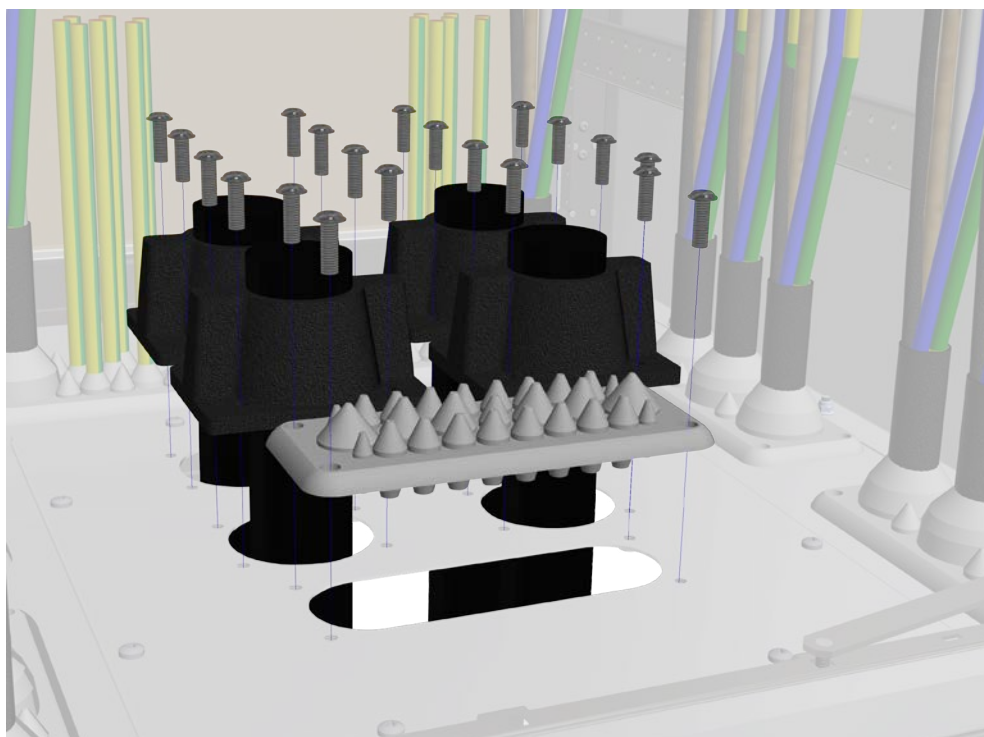

Figure 4.3 Mounting the cable glands

4.2 Protective bonding

It is necessary to interconnect ACD cabinet chassis with main earthing point, to ensure equal potential throughout the installation thus preventing a hazardous potential difference occurring between such parts in the event of a fault.

Connect bonding cable from main earthing point to the bonding copper busbar on the bottom of the cabinet with M6 lug.

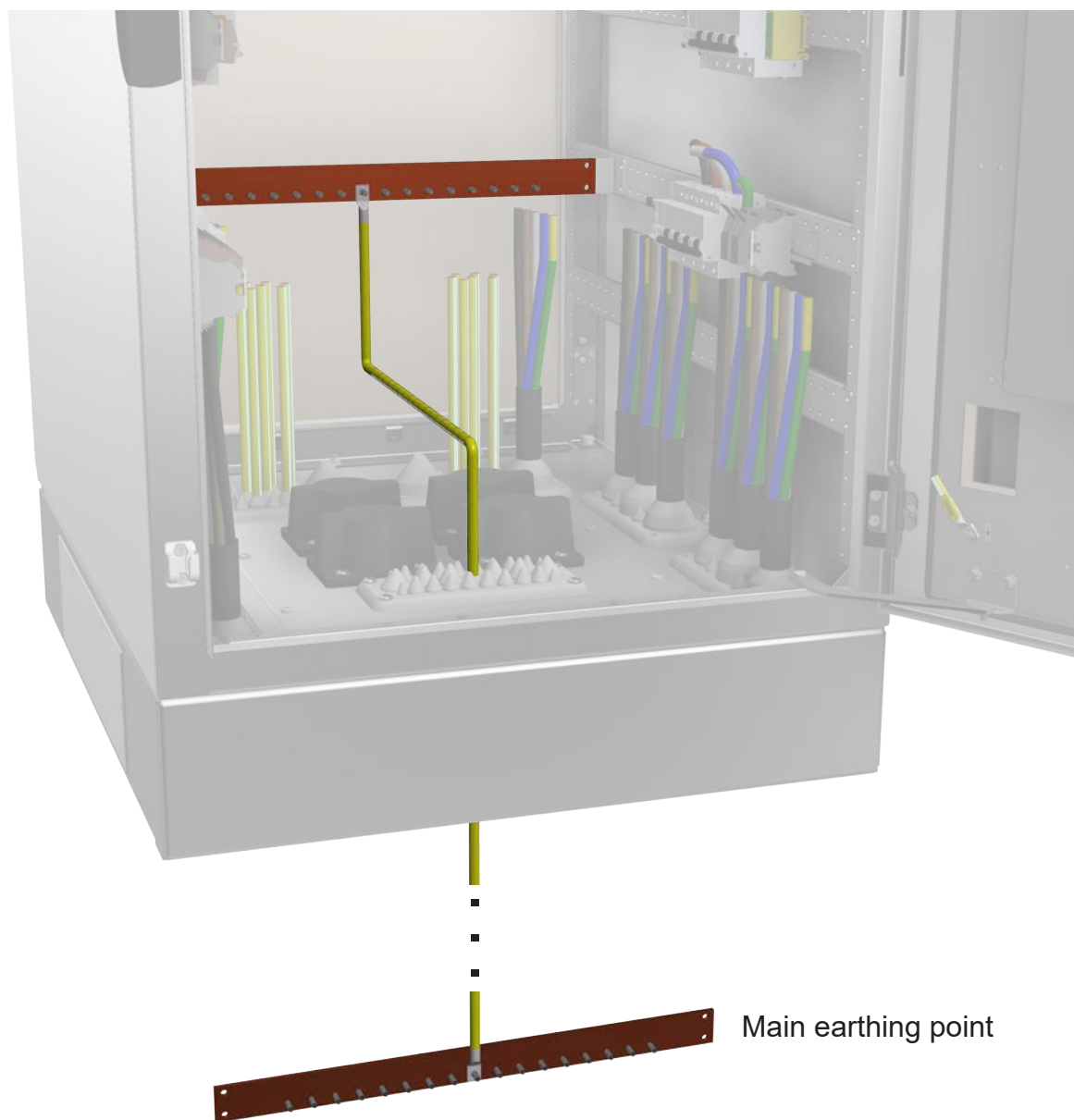

Figure 4.4 Protective bonding

NOTE:

Route cable through the one of the cable glands on the bottom cover.

NOTE:

Do NOT interconnect bonding busbars in multiple cabinets in multicabinet installation. Connect separate bonding cable to each cabinet in multicabinet installation.

4.3 AC Mains Connection

4.3.1 TN-S (230/400Vac)

1. Connect PE wire to PE terminals. Use torque T2.
 - Conductor (CU, AL) 50mm² - 240mm².
2. Connect neutral wire N to neutral terminals. Use torque T2.
 - Conductor (CU, AL) 50mm² - 240mm².
3. Connect phase wires (L1, L2, L3). Use torque T3.
 - Conductor (CU, AL) 95mm² - 240mm².

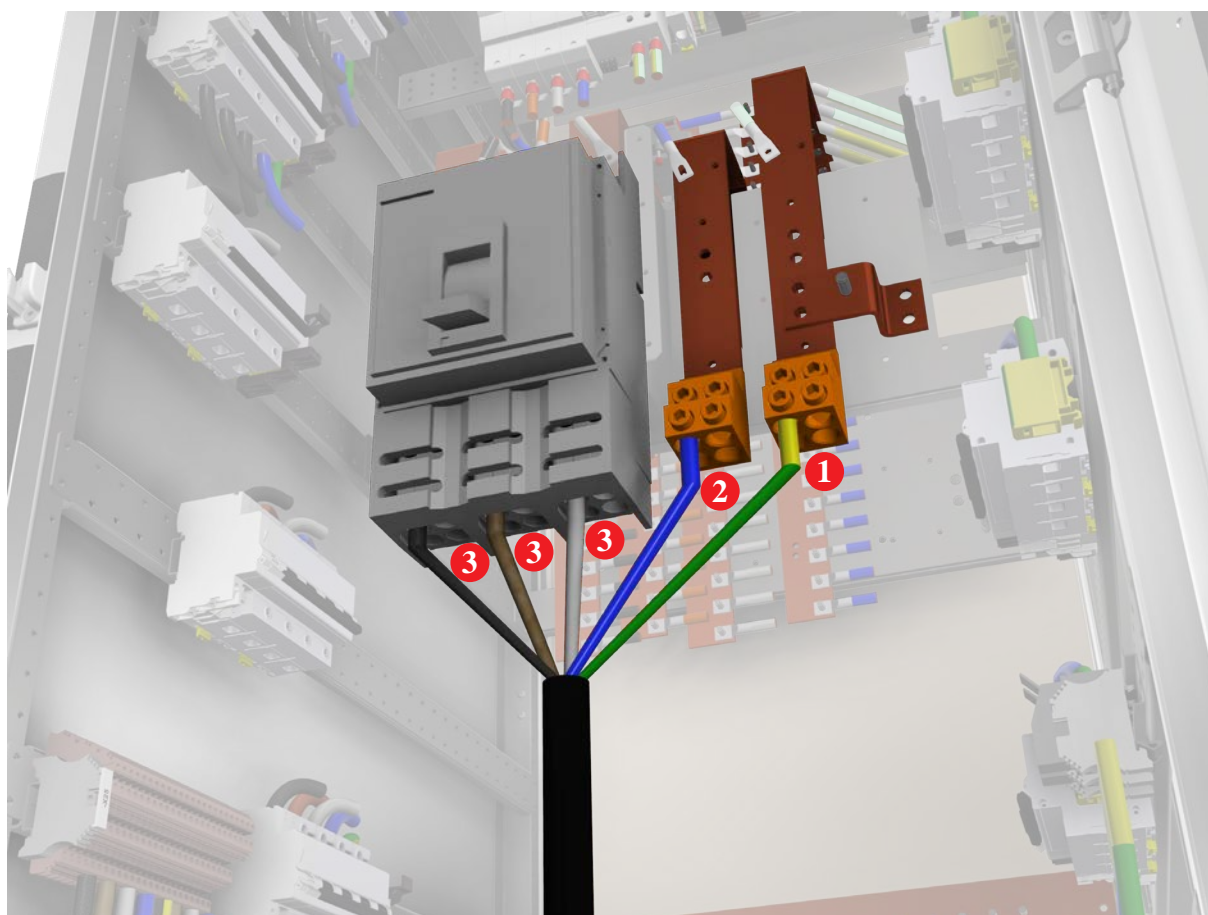

Figure 4.5 AC mains cable - TN-S (230/400Vac)

NOTE:

Number of input cables may differ. Max. number of input cables, capable to install to the input breaker is 4 pieces. Installation steps are same for all cables.

4.3.2 TN-C-S (230/400Vac)

1. Interconnect PE and N busbar with 2x copper link with 4x M10x35 hex bolt, 1xM10 washer and 4x M10 nut.
2. Connect PE wire to PE terminals. Use torque T2.
 - Conductor (CU, AL) 50mm² - 240mm².
3. Connect another PE wire to the PE busbar. Use torque T8.
 - Conductor (CU, AL) 50mm² - 240mm².
4. Connect phase wires (L1, L2, L3). Use torque T3.
 - Conductor (CU, AL) 95mm² - 240mm².

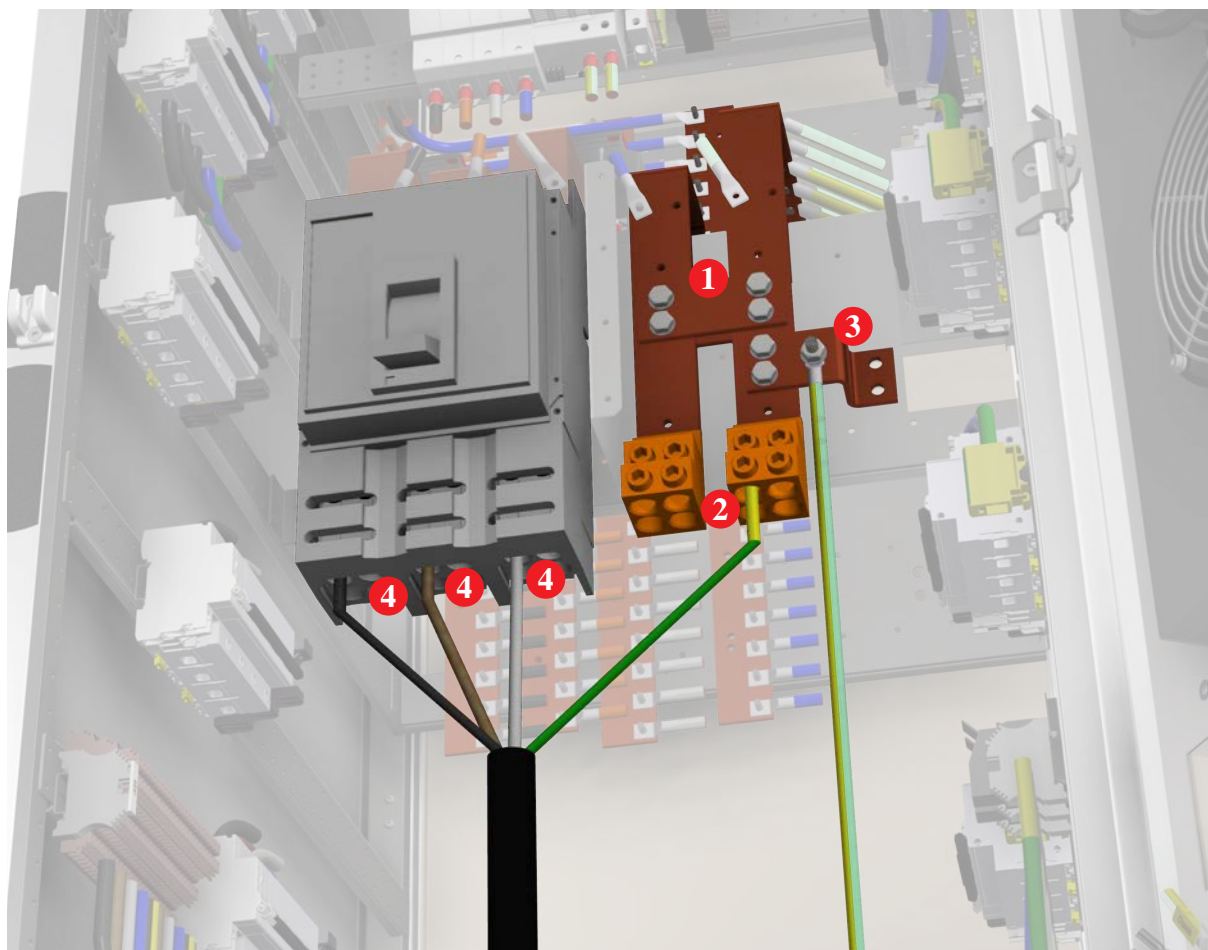

Figure 4.6 AC mains cable - TN-C-S (230/400Vac)

NOTE:

Number of input cables may differ. Max. number of input cables, capable to install to the input breaker is 4 pieces.

4.4 Emergency disconnect switch

Pixii system contains emergency trip device, which in case of emergency can disconnect whole system from the grid. For correct function, external switch with normally open contact and 230Vac backup power supply is required. Connect phase wire to terminal -X20:2 and neutral wire to terminal -X20:4. If 230Vac will be present on terminal -X20, system will disconnect. Placement of external emergency switch depends on local regulations.

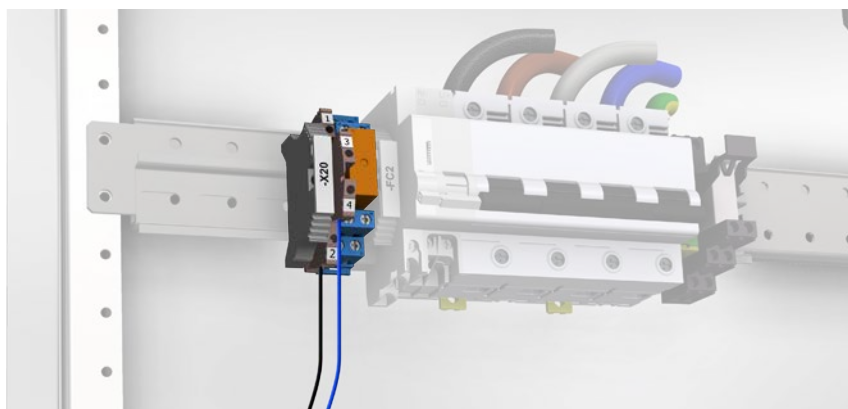

Figure 4.7 Emergency disconnect switch terminals

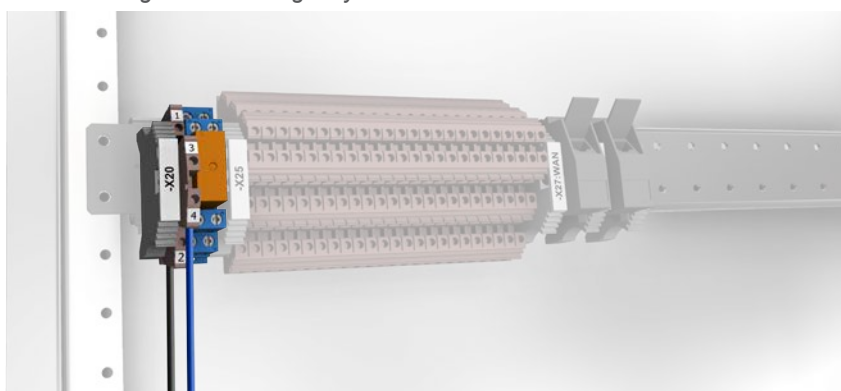

Figure 4.8 Emergency disconnect switch terminals (alternative position)

4.5 System label

Pixii cabinets are marked with 2 system labels. One label is located on the outside of the cabinet (top right part of the cabinet), and one is located inside each cabinet on the cabinet door. Label for whole Power Base is located on the plinth of the ACD cabinet.



Figure 4.9 System labels

4.6 Customer alarm connection

Each Slave Gateway is equipped with 2 alarm relays, that means 28 relays for customer alarm functions for whole Power Base system. All relays are configurable through the software. It could be added different alarm/warning to each of them.

All relays contacts are accessible on connector terminals -X25.

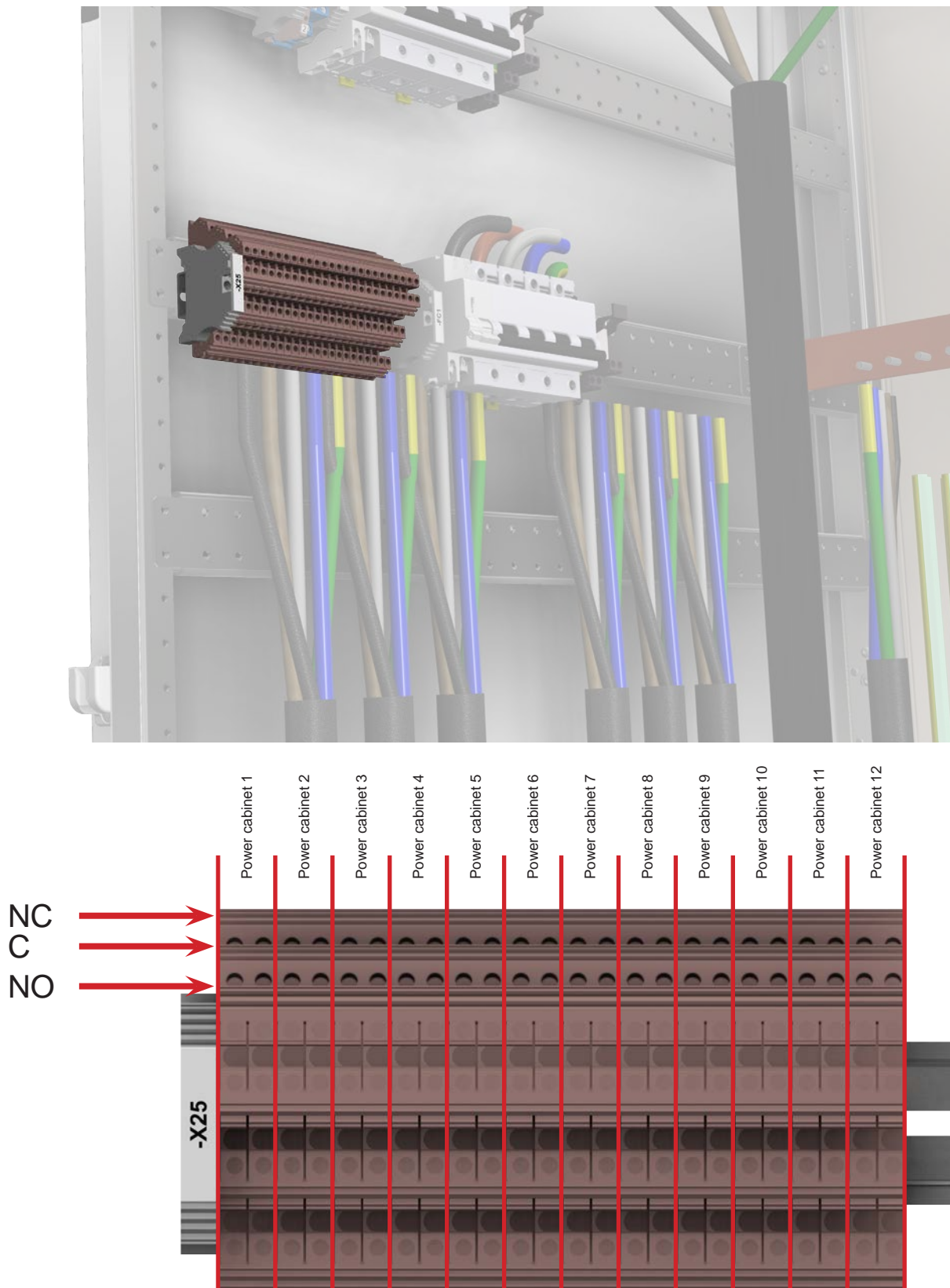

Figure 4.10 Customer alarm connector terminals

4.6.1 Separate alarm

Connect each cabinet to the customer alarm box to ensure finding specific failure.

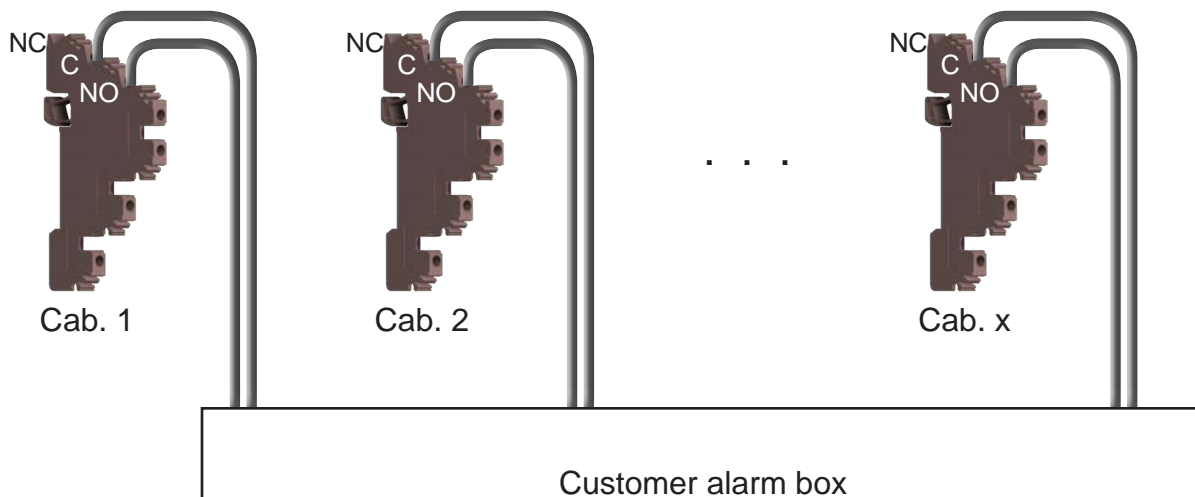

Figure 4.11 Separate alarm

4.6.2 Common alarm

Interconnect cabinets in series and then connect to the customer alarm box. This configuration will be signaling the alarm for whole arrangement.

Alternative 1 (Serial connection of NC-C)

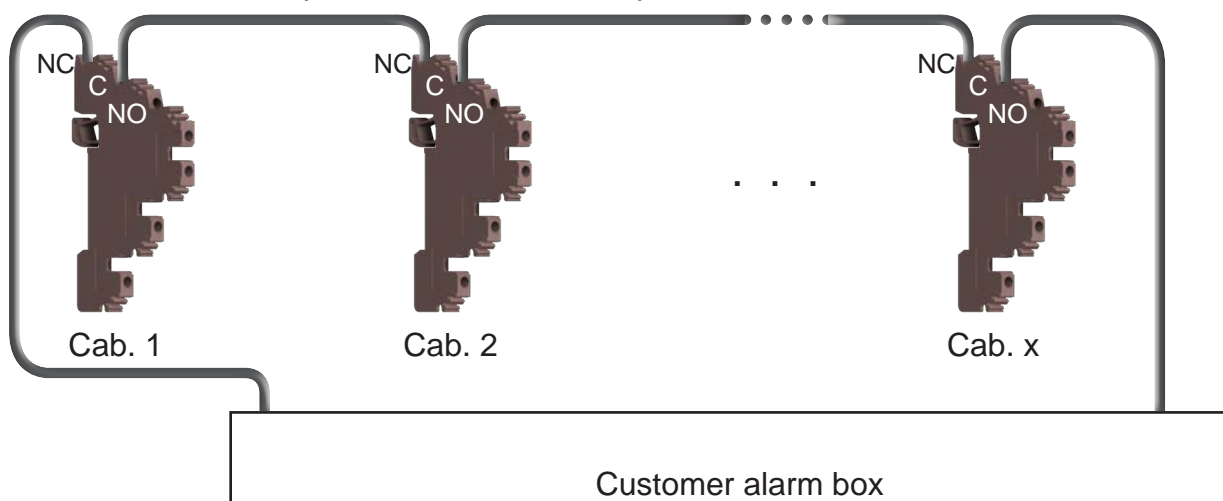

Figure 4.12 Common alarm (Serial)

Alternative 2 (Parallel connection NO-C)

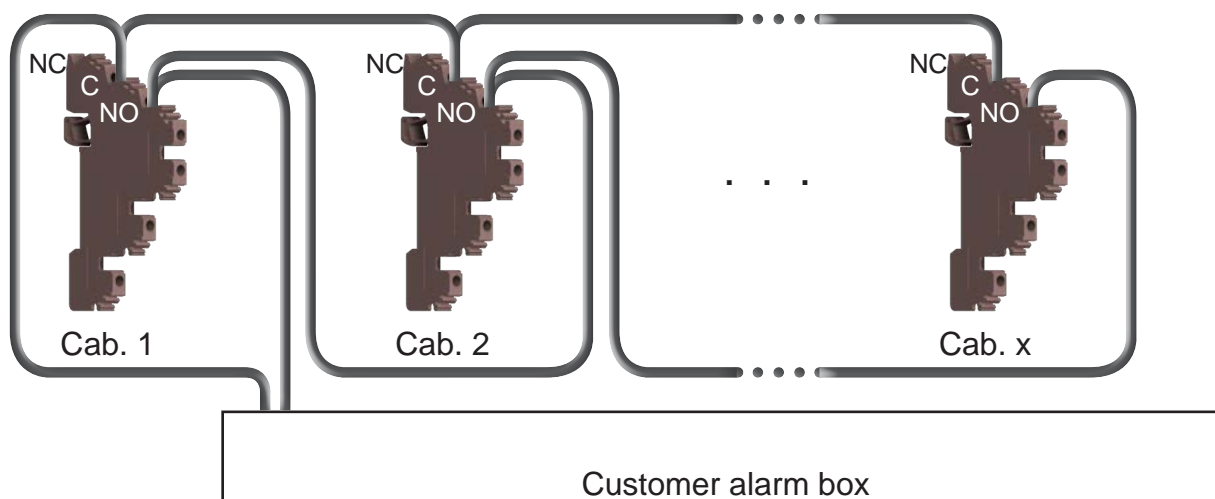

Figure 4.13 Common alarm (Parallel)

4.7 Customer 230V

Pixii system contains 230V terminals -X:23, for customer equipment (AC socket, ...), located on the top right of the cabinet.

Connect PE wire to the terminal -X23:6, phase wire to the terminal -X23:2 and neutral wire to the terminal -X23:4.

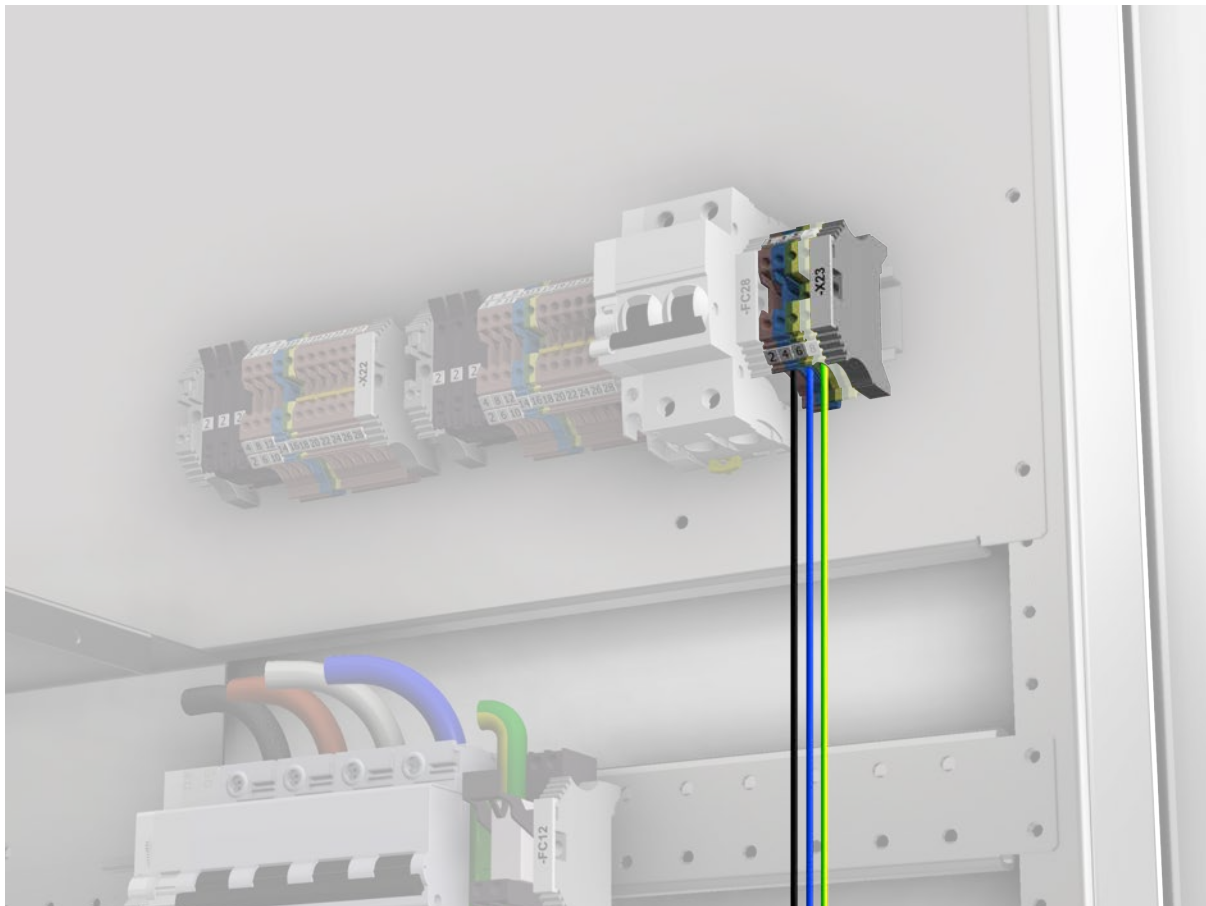

Figure 4.14 Customer 230V terminals

4.8 External communication

Pixii system is fully configurable through web interface. Therefore a network connection to controller is required. This can be done in different ways, depending on what type of network is present on site. The system has a Wi-Fi Access Point that can be activated to access the web interface for configuration and monitoring when at the site. System is also equipped with 4G router that can be used to connect system to Internet. Test report enclosed in system contains the installer login information.

4.8.1 Wi-Fi Access Point

The Wi-Fi Access Point is disabled by default. It may be enabled or disabled by pressing the button found at the upper right hand side (marked by "PB1").

Enable

- Press the button for a duration of between 50ms and maximum of 2 seconds.
- The green led will then blink 2 seconds on and 0.5 seconds off.

Disable

- Press the button for a duration of between 50ms and maximum of 2 seconds.
- The green led will then be lit steady.

The SSID and password are printed on the right side of the controller.

The web page is accessible at <https://10.42.0.1>.

4.8.2 4G router connection

4G router is pre-configured and equipped with activated SIM card. No additional electrical connection is needed.

4.8.3 Ethernet connection

- Route RJ45 network cable from customer switch to ACD cabinet plinth.
- Use cable entry in the bottom cover to enter the cabinet.
- Connect ethernet cable to the connector -X27:WAN.
- Connector -X26 is free position to connect customer equipment.

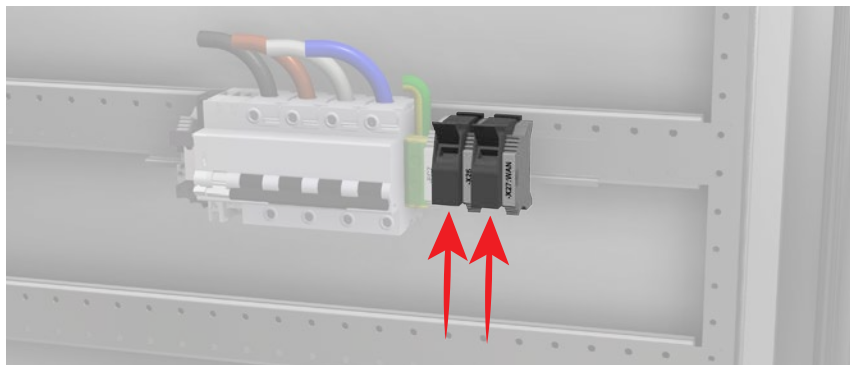

Figure 4.15 Network cable connection

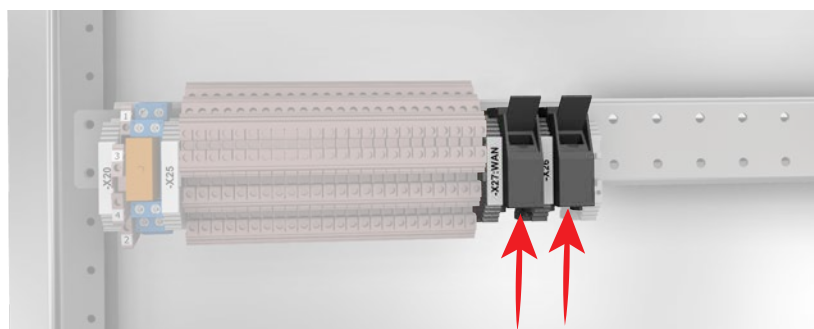

Figure 4.16 Network cable connection (alternative position)

4.9 Customer space

On the top of the ACD cabinet is located 10U space for installation of customer equipment. Cabling are accessible through the rear right corner.

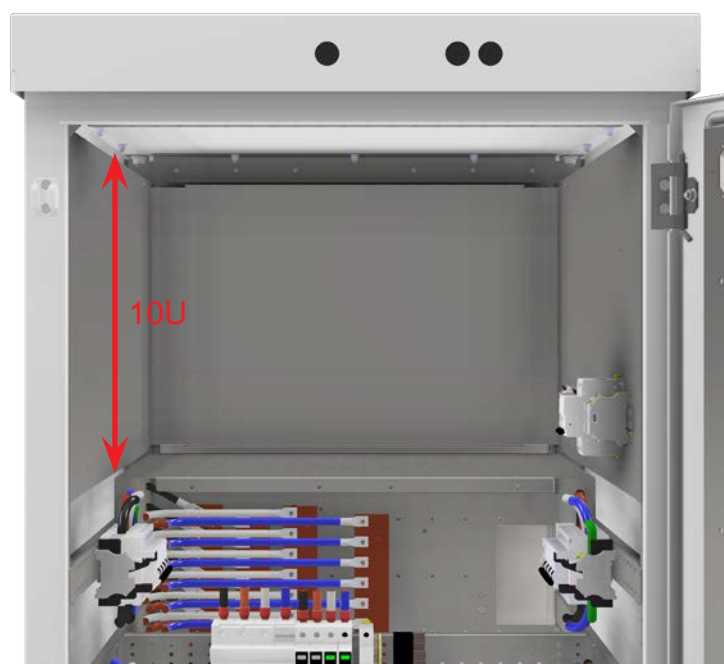

Figure 4.17 Customer space

4.10 AC meter connection

On the top right side of the ACD cabinet are located 2x terminals for power meter connection -X21, -X22.

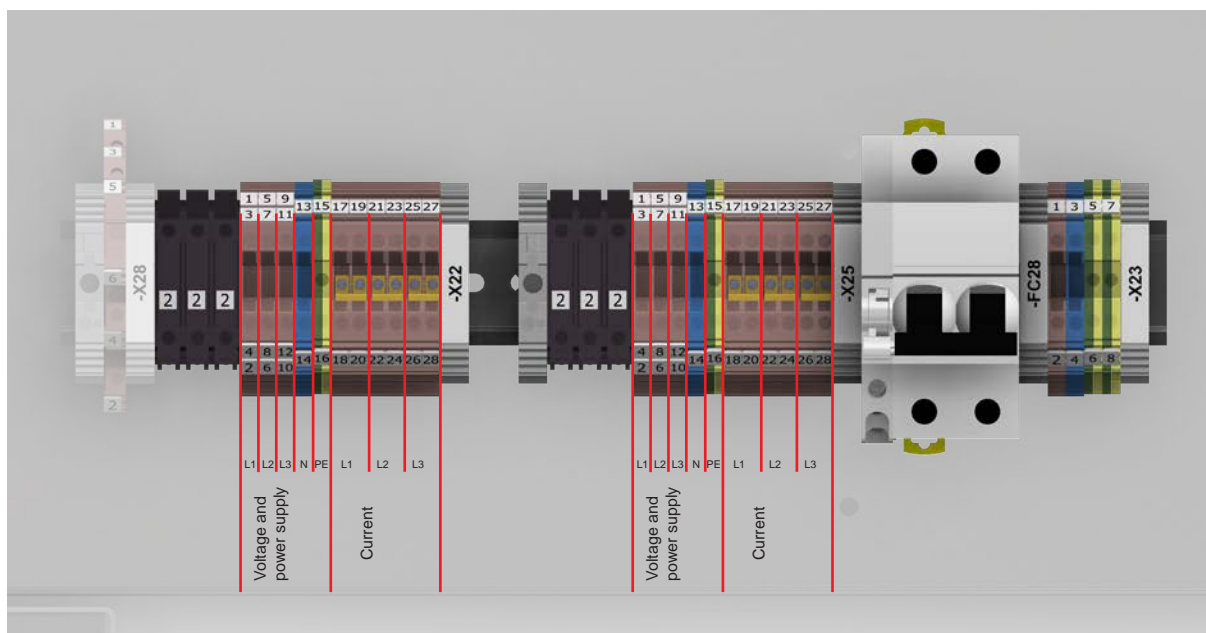

Figure 4.18 Power meter terminals

NOTE:

Remove interconnection from Current terminals after connecting the power meter.

4.11 Customer MODBUS connection RS485

On the top right side of the ACD cabinet are located terminals for MODBUS connection -X28.

Insert and fix:

- connector B to the terminal -X28:2
- connector A to the terminal -X28:4
- connector GND to the terminal -X28:6

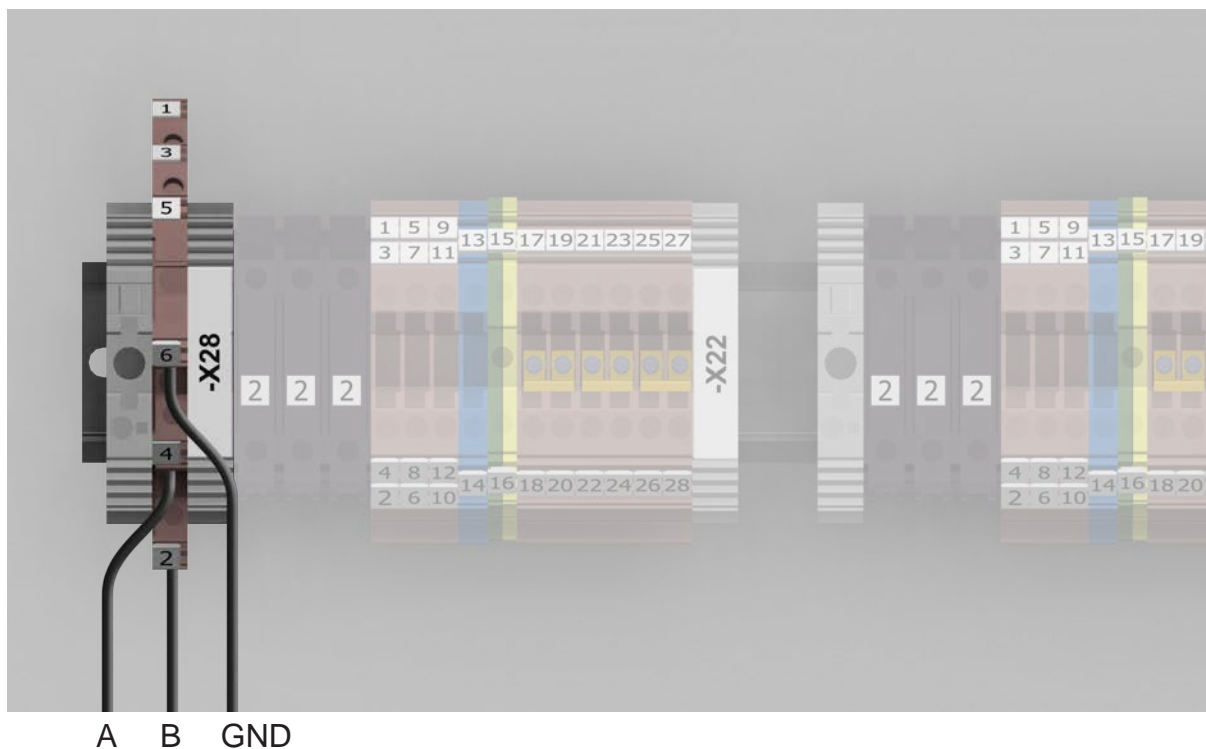

Figure 4.19 Customer MODBUS connection terminals -X28

4.12 Thermostat

A thermostat is located in the ACD cabinet to control the fans located in the cabinet door. It turns the fans ON and OFF based on the internal temperature in the cabinet.

Thermostat is located on the top of the door and is preset from factory to 35°C. Temperature can be adjusted using cog-wheel under the dial.

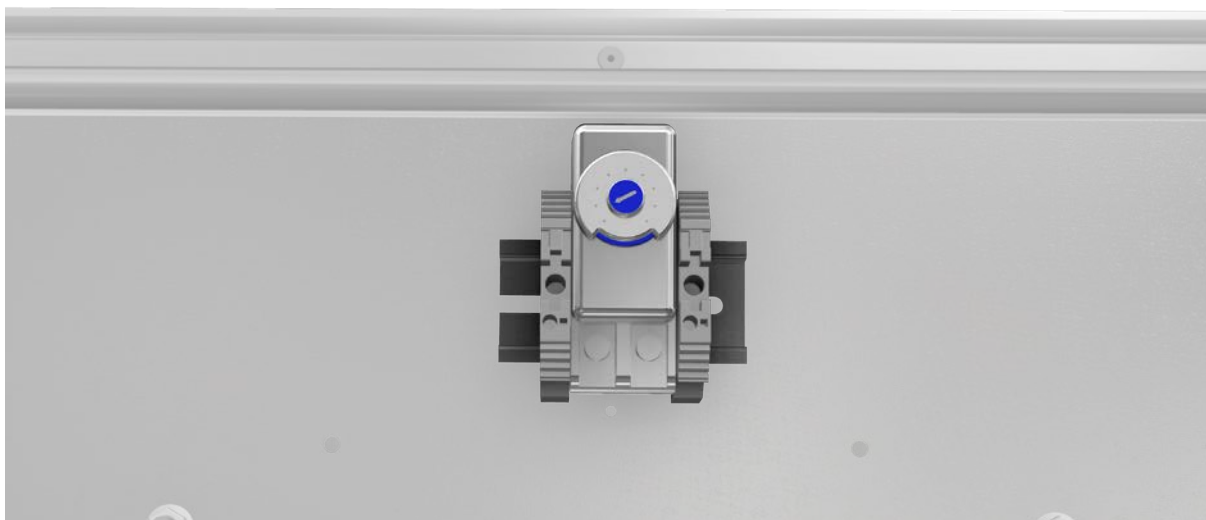

Figure 4.20 Thermostat

4.13 Finalization

After successful installation, mount plastic cover back following steps in chapter “4.1 Preparation” on page 29.

4.14 Installing batteries

Power cabinets (PWM, PWS) are default prepared for 3U batteries (up to 10pcs) from factory, with 148mm spacing between battery supports. It is possible to use 4U batteries (up to 8pcs) as well, but the battery support brackets spacing must be adjusted to 187mm. Bottom battery position is the same for both options.

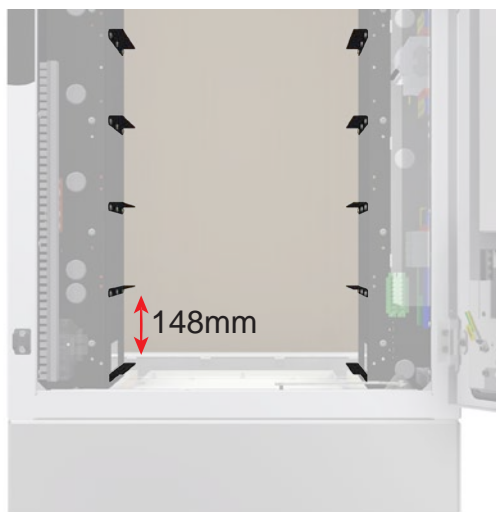

Figure 4.21 3U battery option



Figure 4.22 4U battery option

NOTE:

Flip battery mounting brackets (ears) when using 4U batteries. See picture *Figure 4.23*.

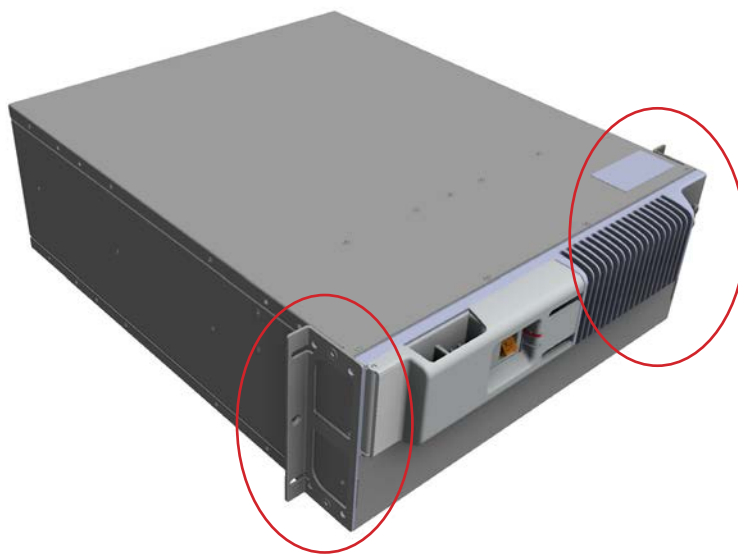

Figure 4.23 Flipped mounting brackets on 4U battery

Using different models of battery modules together is not permitted. Be very careful during installation, because of the high weight of the battery. It's strictly recommended, that batteries are installed by 2 persons. Batteries must be installed in order from bottom to top (see *Figure 4.24*). Place each battery back side at the rails and slowly slide them in correct position. Fix each battery with at least 2x M6 (depending on the accessible holes on the mounting brackets) self tapping screws (see *Figure 4.25*), using torque T5.



Figure 4.24 Battery positions

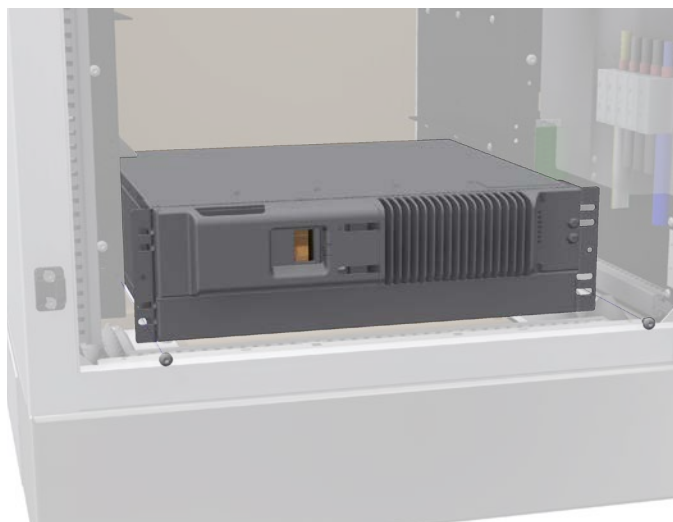

Figure 4.25 Battery installation

NOTE:

Empty battery positions, if any, must be covered by blank panels to obtain correct air flow inside the cabinet.

4.15 Battery connection

Each battery module contains an internal Battery Management System (BMS) and a breaker to secure safe operation. Before connecting the batteries, check once again that all batteries are the same type. If the check was successful, start connecting the batteries.

1. Connect each battery module to those adjacent to it using an intra-rack RJ45 communication cable. For connection use Modbus ports on batteries.
2. Interconnect connector -X21 with the bottom battery Modbus port using attached RJ45 communication cable.
3. Fix cables to avoid contact with fans, heaters and other equipment mounted on door if needed.
4. Connect the positive cable (red, marked -GB1:+) to the bottom battery positive terminal.
5. Connect the negative cable (black, marked -GB1:-) to the bottom battery negative terminal.
6. Repeat step 4 and 5 to connect all other batteries installed in the system (see *Figure 4.27*).

NOTE:

Do not power on batteries at this stage of installation.



Figure 4.26 Battery communication cables



Figure 4.27 Battery cables

NOTE:

For connection of DC battery cables use appropriate torque from chapter “1.1 Recommended tools and torque” on page 8, or follow manufacturer installation documentation.

NOTE:

Insert termination plug to the last unused Modbus port. See details in *Figure 4.26*

NOTE:

Ensure, that battery cables are not in/not colliding with air gap between the batteries. It could cause overheating problems.

4.15.1 Battery Com converter

Proper configuration of converter (-TF2) is necessary to secure the correct communication with various type of batteries. Follow the tables below to set the DIP switches in the right positions.



Figure 4.28 Battery Com converter (-TF2)

	GND	A	B
1	OFF	OFF	ON
2	OFF	ON	OFF
3	OFF	OFF	OFF
4	OFF	OFF	OFF
5	OFF	OFF	OFF
6	OFF	OFF	OFF
7	OFF	ON	OFF
8	ON	OFF	OFF

Shoto batteries configuration table

	GND	A	B
1	OFF	OFF	OFF
2	OFF	OFF	OFF
3	OFF	OFF	OFF
4	OFF	ON	OFF
5	OFF	OFF	ON
6	ON	OFF	OFF
7	OFF	OFF	OFF
8	OFF	OFF	OFF

Polarium batteries configuration table

4.16 Power modules

4.16.1 Installing module

1. Place the module in the shelf and slide in.
2. Using the module handle, push firmly until the unit is properly connected and the ratchet on the left side lock the module in position.



Figure 4.29 Slide the module in



Figure 4.30 Push firmly until the ratchet lock the module

NOTE:

If the module does not fit easily, do not use that power shelf and contact supplier for repair.

4.16.2 Removing module

1. Push the ratchet on the left side to unlock the module.
2. Pull out the module using the handle while holding the ratchet.
3. Replace with a new module or blind panel.



Figure 4.31 Unlock the ratchet



Figure 4.32 Pull the module out

WARNING:

Do NOT touch connectors on the module rear side, there is risk of electric shock because of accumulated energy inside.

NOTE:

Empty positions must be covered with blank panels to obtain correct airflow.

5 Commissioning procedure

For proper commissioning of the system, see separate procedures DN 14608 (14608 - Commissioning procedure - Multicabinet) and 14606 (14606 - Commissioning procedure - Power cabinets).

6 Maintenance

To ensure that the system lifetime will be reached, regular inspections of the system are required. To be within warranty terms of the product the owner must follow the complete maintenance procedure. This procedure can be adapted based on local conditions and regulations. Pixii recommends a complete system maintenance at least once a year, except for filters and air condition unit that may need more frequent inspection based on local environmental conditions.

Only authorized and qualified persons are allowed to perform system maintenance. These persons must be familiar with the system and must follow all precautions described in this manual. Below is a non-exhaustive list of points for general consideration. Do not limit the evaluation to only those points.

NOTE:

For repair and replacement use only original Pixii parts and in accordance with technical specification provided by Pixii. Use of non-original parts may void the warranty provided by Pixii.

6.1 System

- Remove all objects around cabinet that can block air flow.
- Check for physical damage on the cabinet body. Repair scratches with paint. If the cabinet body has severe damage, like deformation or holes, the system should immediately be taken out of operation and replaced with a new cabinet.
- Check the door hinges and apply oil or grease if needed.
- Check that the door gasket has no visible damage.
- Check that all cabinet entry points are correctly sealed and there is no possibility of water and dust entering the cabinet.
- Check the batteries, look for possible leakage and mechanical damage.
- Check that all accessible cables are not mechanically damaged.
- Check that the mains input cable well tightened (Torque table is in chapter "1.1 Recommended tools and torque" on page 8).

6.2 Fan-filter cabinet

- Check that the fans are running without any abnormal noise.
- Disassemble outlet filter frame and visually check filter from both sides.
- Disassemble inlet filter box and visually check filter from both sides.

6.3 Air condition unit

To ensure the normal operation of the air conditioner, please perform regular maintenances.

WARNING:

All the maintenances shall be performed by qualified professionals. Please disconnect the power and signal cables of the air conditioner before any maintenance and do not reconnect them until the maintenance is completed.

Check item	Step description	Maintenance cycle
Wiring	Visually check if the wiring is loose	12 months
Fan abnormalities	Turn the fan to check if it is smooth and if there is any abnormal noise	12 months
Drainage pipe	Visually check if the drainage mouth is blocked	6 months
Condenser	Check the cleanness of the condenser and clean it with compressed air	6 months

After the air conditioner is power on, check whether the air conditioner enter the normal interface, without alarm. And then perform the self testing and check whether the whole process is normal.



• ••
PIXII

